

# H:40 STANDART DELİKLİ KABLO KANALLARI

## H:40 STANDARD PERFORATED CABLE TRAYS

**el-ka**

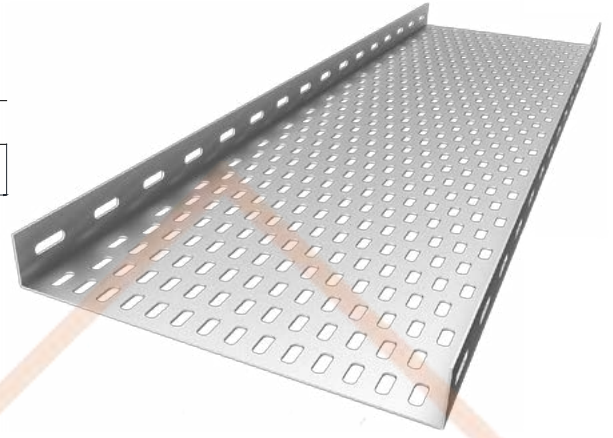
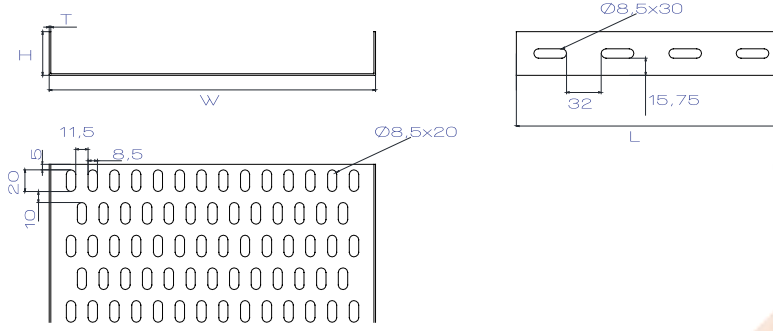

### H:40 STANDART DELİKLİ KABLO KANALLARI / H:40 STANDARD PERFORATED CABLE TRAYS

Ürün Kodu / Product Code		(W) En Width (mm)	(H) Yükseklik Height (mm)	(T) Kalınlık Thickness (mm)	Ürt. Ağırlık Mnf. Weight (kg/mt)	(L) Boy Length (mm)
Pregalvaniz (PG)	Sıcak Daldırma (HDG)					
EK SPK 50-40-08 PG	-	50	40	0,80	0,82	2500
EK SPK 50-40-10 PG	EK SPK 50-40-10 HDG	50	40	1,00	1,02	2500
EK SPK 50-40-12 PG	EK SPK 50-40-12 HDG	50	40	1,20	1,22	2500
EK SPK 50-40-15 PG	EK SPK 50-40-15 HDG	50	40	1,50	1,53	2500
EK SPK 70-40-08 PG	-	70	40	0,80	0,94	2500
EK SPK 70-40-10 PG	EK SPK 70-40-10 HDG	70	40	1,00	1,18	2500
EK SPK 70-40-12 PG	EK SPK 70-40-12 HDG	70	40	1,20	1,41	2500
EK SPK 70-40-15 PG	EK SPK 70-40-15 HDG	70	40	1,50	1,77	2500
EK SPK 100-40-08 PG	-	100	40	0,80	1,13	2500
EK SPK 100-40-10 PG	EK SPK 100-40-10 HDG	100	40	1,00	1,41	2500
EK SPK 100-40-12 PG	EK SPK 100-40-12 HDG	100	40	1,20	1,70	2500
EK SPK 100-40-15 PG	EK SPK 100-40-15 HDG	100	40	1,50	2,12	2500
EK SPK 120-40-10 PG	EK SPK 120-40-10 HDG	120	40	1,00	1,57	2500
EK SPK 120-40-12 PG	EK SPK 120-40-12 HDG	120	40	1,20	1,88	2500
EK SPK 120-40-15 PG	EK SPK 120-40-15 HDG	120	40	1,50	2,36	2500
EK SPK 160-40-10 PG	EK SPK 160-40-10 HDG	160	40	1,00	1,88	2500
EK SPK 160-40-12 PG	EK SPK 160-40-12 HDG	160	40	1,20	2,26	2500
EK SPK 160-40-15 PG	EK SPK 160-40-15 HDG	160	40	1,50	2,83	2500
EK SPK 200-40-10 PG	-	200	40	1,00	2,20	2500
EK SPK 200-40-12 PG	-	200	40	1,20	2,64	2500
EK SPK 200-40-15 PG	EK SPK 200-40-15 HDG	200	40	1,50	3,30	2500
EK SPK 200-40-20 PG	EK SPK 200-40-20 HDG	200	40	2,00	4,40	2500
EK SPK 260-40-12 PG	EK SPK 260-40-12 HDG	260	40	1,20	3,20	2500
EK SPK 260-40-15 PG	EK SPK 260-40-15 HDG	260	40	1,50	4,00	2500
EK SPK 260-40-20 PG	EK SPK 260-40-20 HDG	260	40	2,00	5,34	2500
EK SPK 300-40-12 PG	-	300	40	1,20	3,58	2500
EK SPK 300-40-15 PG	EK SPK 300-40-15 HDG	300	40	1,50	4,47	2500
EK SPK 300-40-20 PG	EK SPK 300-40-20 HDG	300	40	2,00	5,97	2500
EK SPK 400-40-12 PG	-	400	40	1,20	4,52	2500
EK SPK 400-40-15 PG	EK SPK 400-40-15 HDG	400	40	1,50	5,65	2500
EK SPK 400-40-20 PG	EK SPK 400-40-20 HDG	400	40	2,00	7,54	2500
EK SPK 500-40-15 PG	EK SPK 500-40-15 HDG	500	40	1,50	6,83	2500
EK SPK 500-40-20 PG	EK SPK 500-40-20 HDG	500	40	2,00	9,11	2500
EK SPK 600-40-15 PG	EK SPK 600-40-15 HDG	600	40	1,50	8,01	2500
EK SPK 600-40-20 PG	EK SPK 600-40-20 HDG	600	40	2,00	10,68	2500

H:40 Standard Cable Tray Load Graph

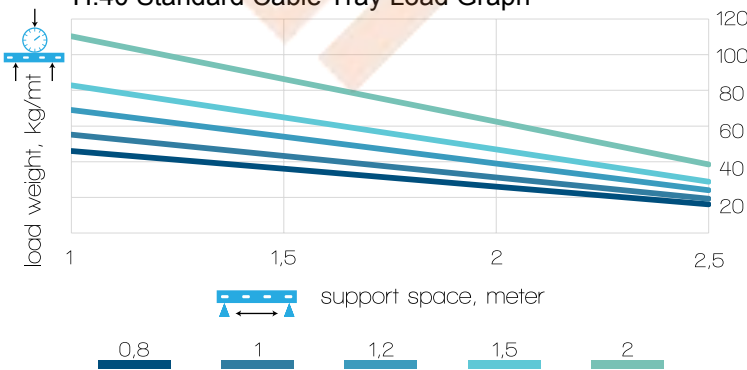

Permissible loads for a maximum deflection of 1/100th of the span, with coupling positioned at 1/5th of the span from support. The coefficient applied to the load for coupling in the middle of the span: 0.7

Safety co-efficient: 1.7

Recommended support distance: 1.5mt

Güvenlik katsayısı: 1,7

Tavsiye edilen destek konsol aralığı: 1,5mt

# H:40 STANDART DELİKSİZ KABLO KANALLARI

## H:40 STANDARD NON-PERFORATED CABLE TRAYS

**el-ka**

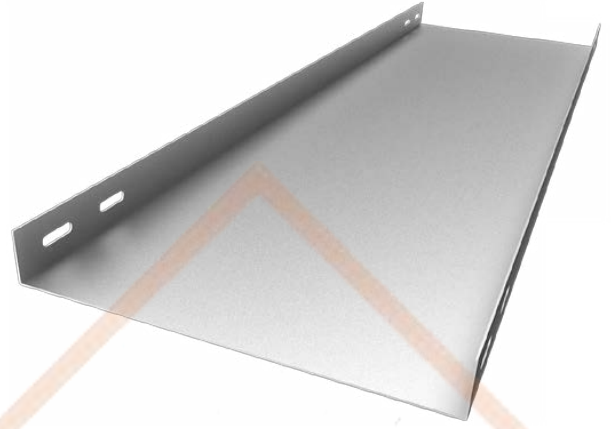
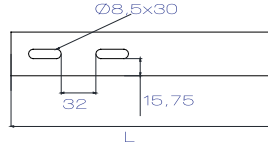
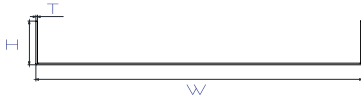

### H:40 STANDART DELİKSİZ KABLO KANALLARI / H:40 STANDARD NON-PERFORATED CABLE TRAYS

Ürün Kodu / Product Code		(W) En Width (mm)	(H) Yükseklik Height (mm)	(T) Kalınlık Thickness (mm)	Ürt. Ağırlık Mnf. Weight (kg/mt)	(L) Boy Length (mm)
Pregalvaniz (PG)	Sıcak Daldırma (HDG)					
EK SDK 50-40-08 PG	-	50	40	0,80	0,82	2500
EK SDK 50-40-10 PG	EK SDK 50-40-10 HDG	50	40	1,00	1,02	2500
EK SDK 50-40-12 PG	EK SDK 50-40-12 HDG	50	40	1,20	1,22	2500
EK SDK 50-40-15 PG	EK SDK 50-40-15 HDG	50	40	1,50	1,53	2500
EK SDK 70-40-08 PG	-	70	40	0,80	0,94	2500
EK SDK 70-40-10 PG	EK SDK 70-40-10 HDG	70	40	1,00	1,18	2500
EK SDK 70-40-12 PG	EK SDK 70-40-12 HDG	70	40	1,20	1,41	2500
EK SDK 70-40-15 PG	EK SDK 70-40-15 HDG	70	40	1,50	1,77	2500
EK SDK 100-40-08 PG	-	100	40	0,80	1,13	2500
EK SDK 100-40-10 PG	EK SDK 100-40-10 HDG	100	40	1,00	1,41	2500
EK SDK 100-40-12 PG	EK SDK 100-40-12 HDG	100	40	1,20	1,70	2500
EK SDK 100-40-15 PG	EK SDK 100-40-15 HDG	100	40	1,50	2,12	2500
EK SDK 120-40-10 PG	EK SDK 120-40-10 HDG	120	40	1,00	1,57	2500
EK SDK 120-40-12 PG	EK SDK 120-40-12 HDG	120	40	1,20	1,88	2500
EK SDK 120-40-15 PG	EK SDK 120-40-15 HDG	120	40	1,50	2,36	2500
EK SDK 160-40-10 PG	EK SDK 160-40-10 HDG	160	40	1,00	1,88	2500
EK SDK 160-40-12 PG	EK SDK 160-40-12 HDG	160	40	1,20	2,26	2500
EK SDK 160-40-15 PG	EK SDK 160-40-15 HDG	160	40	1,50	2,83	2500
EK SDK 200-40-10 PG	-	200	40	1,00	2,20	2500
EK SDK 200-40-12 PG	-	200	40	1,20	2,64	2500
EK SDK 200-40-15 PG	EK SDK 200-40-15 HDG	200	40	1,50	3,30	2500
EK SDK 200-40-20 PG	EK SDK 200-40-20 HDG	200	40	2,00	4,40	2500
EK SDK 260-40-12 PG	EK SDK 260-40-12 HDG	260	40	1,20	3,20	2500
EK SDK 260-40-15 PG	EK SDK 260-40-15 HDG	260	40	1,50	4,00	2500
EK SDK 260-40-20 PG	EK SDK 260-40-20 HDG	260	40	2,00	5,34	2500
EK SDK 300-40-12 PG	-	300	40	1,20	3,58	2500
EK SDK 300-40-15 PG	EK SDK 300-40-15 HDG	300	40	1,50	4,47	2500
EK SDK 300-40-20 PG	EK SDK 300-40-20 HDG	300	40	2,00	5,97	2500
EK SDK 400-40-12 PG	-	400	40	1,20	4,52	2500
EK SDK 400-40-15 PG	EK SDK 400-40-15 HDG	400	40	1,50	5,65	2500
EK SDK 400-40-20 PG	EK SDK 400-40-20 HDG	400	40	2,00	7,54	2500
EK SDK 500-40-15 PG	EK SDK 500-40-15 HDG	500	40	1,50	6,83	2500
EK SDK 500-40-20 PG	EK SDK 500-40-20 HDG	500	40	2,00	9,11	2500
EK SDK 600-40-15 PG	EK SDK 600-40-15 HDG	600	40	1,50	8,01	2500
EK SDK 600-40-20 PG	EK SDK 600-40-20 HDG	600	40	2,00	10,68	2500

H:40 Standard Cable Tray Load Graph

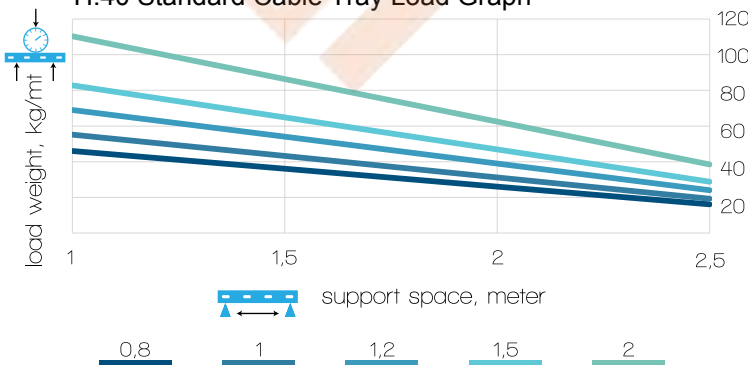

Permissible loads for a maximum deflection of 1/100th of the span, with coupling positioned at 1/5th of the span from support. The coefficient applied to the load for coupling in the middle of the span: 0.7

Safety co-efficient: 1.7

Recommended support distance: 1.5mt

Güvenlik katsayısı: 1,7

Tavsiye edilen destek konsol aralığı: 1,5mt

# H:40 AĞIR HİZMET DELİKLİ KABLO KANALLARI H:40 HEAVY DUTY PERFORATED CABLE TRAYS

**el-ka**

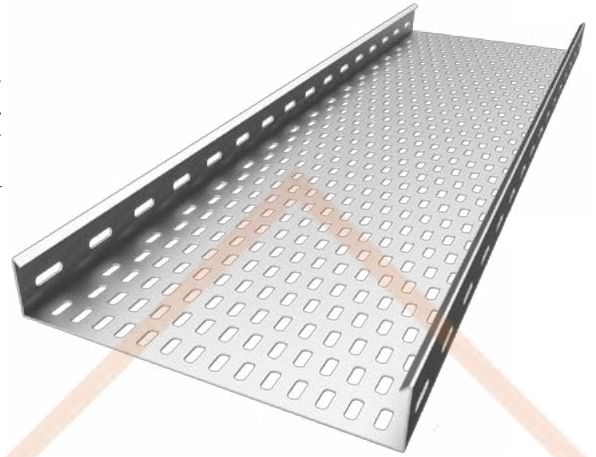
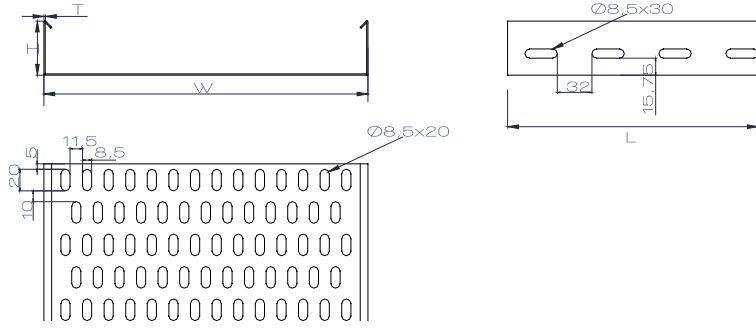

## H:40 AĞIR HİZMET DELİKLİ KABLO KANALLARI / H:40 HEAVY DUTY PERFORATED CABLE TRAYS

Ürün Kodu / Product Code		(W) En Width (mm)	(H) Yükseklik Height (mm)	(T) Kalınlık Thickness (mm)	Ürt. Ağırlık Mnf. Weight (kg/mt)	(L) Boy Length (mm)
<b>Pregalvaniz (PG)</b>	<b>Sıcak Daldırma (HDG)</b>					
EK APK 50-40-08 PG	-	50	40	0,80	0,94	2500
EK APK 50-40-10 PG	EK APK 50-40-10 HDG	50	40	1,00	1,18	2500
EK APK 50-40-12 PG	EK APK 50-40-12 HDG	50	40	1,20	1,41	2500
EK APK 50-40-15 PG	EK APK 50-40-15 HDG	50	40	1,50	1,77	2500
EK APK 70-40-08 PG	-	70	40	0,80	1,07	2500
EK APK 70-40-10 PG	EK APK 70-40-10 HDG	70	40	1,00	1,33	2500
EK APK 70-40-12 PG	EK APK 70-40-12 HDG	70	40	1,20	1,60	2500
EK APK 70-40-15 PG	EK APK 70-40-15 HDG	70	40	1,50	2,00	2500
EK APK 100-40-08 PG	-	100	40	0,80	1,26	2500
EK APK 100-40-10 PG	EK APK 100-40-10 HDG	100	40	1,00	1,57	2500
EK APK 100-40-12 PG	EK APK 100-40-12 HDG	100	40	1,20	1,88	2500
EK APK 100-40-15 PG	EK APK 100-40-15 HDG	100	40	1,50	2,36	2500
EK APK 120-40-10 PG	EK APK 120-40-10 HDG	120	40	1,00	1,73	2500
EK APK 120-40-12 PG	EK APK 120-40-12 HDG	120	40	1,20	2,07	2500
EK APK 120-40-15 PG	EK APK 120-40-15 HDG	120	40	1,50	2,59	2500
EK APK 160-40-10 PG	EK APK 160-40-10 HDG	160	40	1,00	2,04	2500
EK APK 160-40-12 PG	EK APK 160-40-12 HDG	160	40	1,20	2,45	2500
EK APK 160-40-15 PG	EK APK 160-40-15 HDG	160	40	1,50	3,06	2500
EK APK 200-40-10 PG	-	200	40	1,00	2,36	2500
EK APK 200-40-12 PG	-	200	40	1,20	2,83	2500
EK APK 200-40-15 PG	EK APK 200-40-15 HDG	200	40	1,50	3,53	2500
EK APK 200-40-20 PG	EK APK 200-40-20 HDG	200	40	2,00	4,71	2500
EK APK 260-40-12 PG	EK APK 260-40-12 HDG	260	40	1,20	3,39	2500
EK APK 260-40-15 PG	EK APK 260-40-15 HDG	260	40	1,50	4,24	2500
EK APK 260-40-20 PG	EK APK 260-40-20 HDG	260	40	2,00	5,65	2500
EK APK 300-40-12 PG	-	300	40	1,20	3,77	2500
EK APK 300-40-15 PG	EK APK 300-40-15 HDG	300	40	1,50	4,71	2500
EK APK 300-40-20 PG	EK APK 300-40-20 HDG	300	40	2,00	6,28	2500
EK APK 400-40-12 PG	-	400	40	1,20	4,71	2500
EK APK 400-40-15 PG	EK APK 400-40-15 HDG	400	40	1,50	5,89	2500
EK APK 400-40-20 PG	EK APK 400-40-20 HDG	400	40	2,00	7,85	2500
EK APK 500-40-15 PG	EK APK 500-40-15 HDG	500	40	1,50	7,07	2500
EK APK 500-40-20 PG	EK APK 500-40-20 HDG	500	40	2,00	9,42	2500
EK APK 600-40-15 PG	EK APK 600-40-15 HDG	600	40	1,50	8,24	2500
EK APK 600-40-20 PG	EK APK 600-40-20 HDG	600	40	2,00	10,99	2500

H:40 Heavy Duty Cable Tray Load Graph

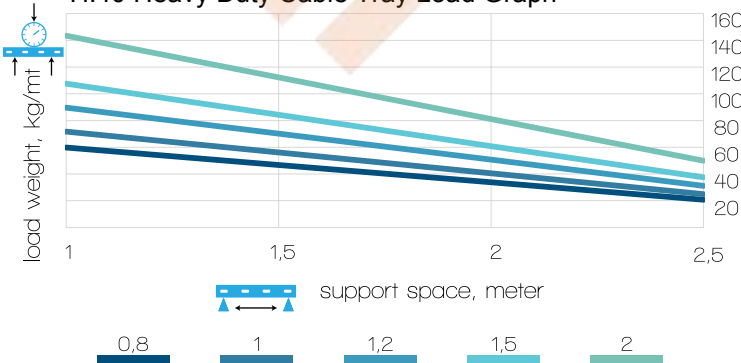

Permissible loads for a maximum deflection of 1/100th of the span, with coupling positioned at 1/5th of the span from support. The coefficient applied to the load for coupling in the middle of the span: 0.7

Safety co-efficient: 1.7

Recommended support distance: 1.5mt

Güvenlik katsayısı: 1,7

Tavsiye edilen destek konsol aralığı: 1,5mt

# H:40 AĞIR HİZMET DELİKSİZ KABLO KANALLARI

## H:40 HEAVY DUTY NON-PERFORATED CABLE TRAYS

**el-ka**

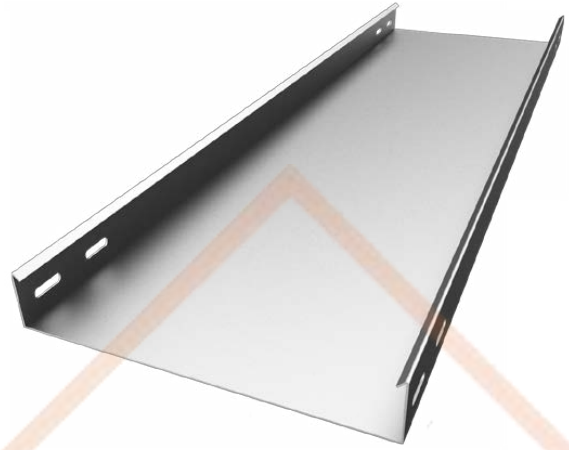
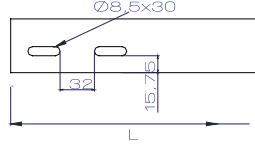
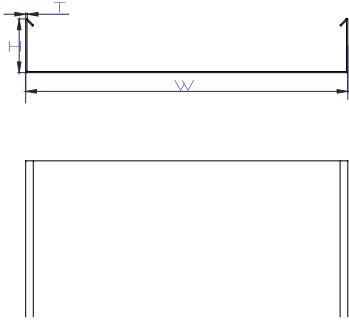

### H:40 AĞIR HİZMET DELİKSİZ KABLO KANALLARI / H:40 HEAVY DUTY NON-PERFORATED CABLE TRAYS

Ürün Kodu / Product Code		(W) En Width (mm)	(H) Yükseklik Height (mm)	(T) Kalınlık Thickness (mm)	Ürt. Ağırlık Mnf. Weight (kg/mt)	(L) Boy Length (mm)
Pregalvaniz (PG)	Sıcak Daldırma (HDG)					
EK ADK 50-40-08 PG	-	50	40	0,80	0,94	2500
EK ADK 50-40-10 PG	EK ADK 50-40-10 HDG	50	40	1,00	1,18	2500
EK ADK 50-40-12 PG	EK ADK 50-40-12 HDG	50	40	1,20	1,41	2500
EK ADK 50-40-15 PG	EK ADK 50-40-15 HDG	50	40	1,50	1,77	2500
EK ADK 70-40-08 PG	-	70	40	0,80	1,07	2500
EK ADK 70-40-10 PG	EK ADK 70-40-10 HDG	70	40	1,00	1,33	2500
EK ADK 70-40-12 PG	EK ADK 70-40-12 HDG	70	40	1,20	1,60	2500
EK ADK 70-40-15 PG	EK ADK 70-40-15 HDG	70	40	1,50	2,00	2500
EK ADK 100-40-08 PG	-	100	40	0,80	1,26	2500
EK ADK 100-40-10 PG	EK ADK 100-40-10 HDG	100	40	1,00	1,57	2500
EK ADK 100-40-12 PG	EK ADK 100-40-12 HDG	100	40	1,20	1,88	2500
EK ADK 100-40-15 PG	EK ADK 100-40-15 HDG	100	40	1,50	2,36	2500
EK ADK 120-40-10 PG	EK ADK 120-40-10 HDG	120	40	1,00	1,73	2500
EK ADK 120-40-12 PG	EK ADK 120-40-12 HDG	120	40	1,20	2,07	2500
EK ADK 120-40-15 PG	EK ADK 120-40-15 HDG	120	40	1,50	2,59	2500
EK ADK 160-40-10 PG	EK ADK 160-40-10 HDG	160	40	1,00	2,04	2500
EK ADK 160-40-12 PG	EK ADK 160-40-12 HDG	160	40	1,20	2,45	2500
EK ADK 160-40-15 PG	EK ADK 160-40-15 HDG	160	40	1,50	3,06	2500
EK ADK 200-40-10 PG	-	200	40	1,00	2,36	2500
EK ADK 200-40-12 PG	-	200	40	1,20	2,83	2500
EK ADK 200-40-15 PG	EK ADK 200-40-15 HDG	200	40	1,50	3,53	2500
EK ADK 200-40-20 PG	EK ADK 200-40-20 HDG	200	40	2,00	4,71	2500
EK ADK 260-40-12 PG	EK ADK 260-40-12 HDG	260	40	1,20	3,39	2500
EK ADK 260-40-15 PG	EK ADK 260-40-15 HDG	260	40	1,50	4,24	2500
EK ADK 260-40-20 PG	EK ADK 260-40-20 HDG	260	40	2,00	5,65	2500
EK ADK 300-40-12 PG	-	300	40	1,20	3,77	2500
EK ADK 300-40-15 PG	EK ADK 300-40-15 HDG	300	40	1,50	4,71	2500
EK ADK 300-40-20 PG	EK ADK 300-40-20 HDG	300	40	2,00	6,28	2500
EK ADK 400-40-12 PG	-	400	40	1,20	4,71	2500
EK ADK 400-40-15 PG	EK ADK 400-40-15 HDG	400	40	1,50	5,89	2500
EK ADK 400-40-20 PG	EK ADK 400-40-20 HDG	400	40	2,00	7,85	2500
EK ADK 500-40-15 PG	EK ADK 500-40-15 HDG	500	40	1,50	7,07	2500
EK ADK 500-40-20 PG	EK ADK 500-40-20 HDG	500	40	2,00	9,42	2500
EK ADK 600-40-15 PG	EK ADK 600-40-15 HDG	600	40	1,50	8,24	2500
EK ADK 600-40-20 PG	EK ADK 600-40-20 HDG	600	40	2,00	10,99	2500

H:40 Heavy Duty Cable Tray Load Graph

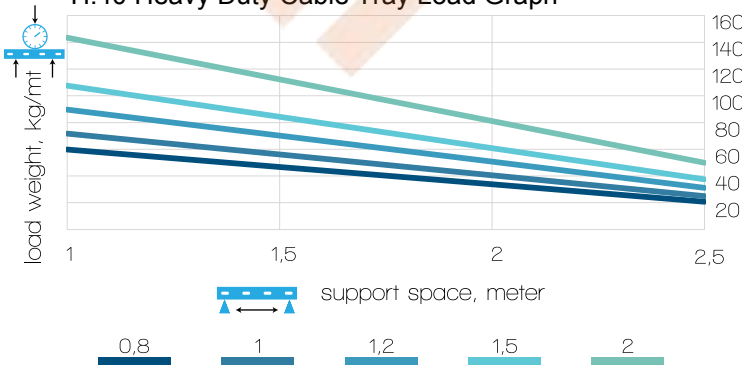

Permissible loads for a maximum deflection of 1/100th of the span, with coupling positioned at 1/5th of the span from support. The coefficient applied to the load for coupling in the middle of the span: 0.7

Safety co-efficient: 1.7

Recommended support distance: 1.5mt

Güvenlik katsayısı: 1,7

Tavsiye edilen destek konsol aralığı: 1,5mt

H:40 Birleştirme Ek Elemanı / H:40 Straight Coupler

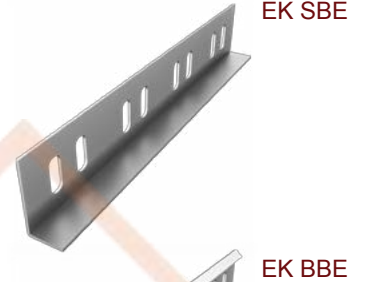
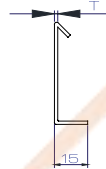
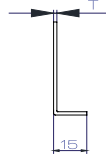
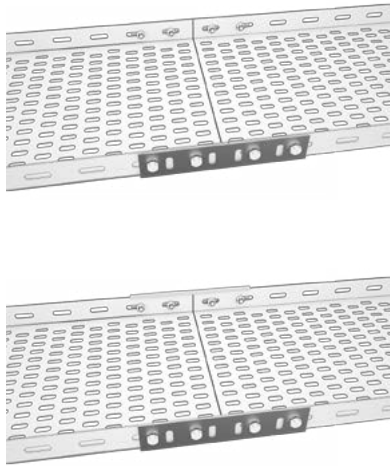

EK SBE

EK BBE

H:40 BİRLEŞTİRME EK ELEMANI / H:40 STRAIGHT CONNECTOR

Ürün Kodu / Product Code		(H) Yükseklik Height (mm)	(T) Kalınlık Thickness (mm)	Ürt. Ağırlık Mnf. Weight (kg/adet)
Pregalvaniz (PG)	Sıcak Daldırma (HDG)			
EK SBE 40-12 PG	EK SBE 40-12 HDG	40	1,20	0,13
EK SBE 40-15 PG	EK SBE 40-15 HDG	40	1,50	0,16
EK BBE 40-12 PG	EK BBE 40-12 HDG	40	1,20	0,15
EK BBE 40-15 PG	EK BBE 40-15 HDG	40	1,50	0,19

M8 CİVATA VE SOMUN / M8 BOLT & NUT



Ürün Kodu / Product Code		Ebat Size (mm)	Ağırlık Weight (kg/adet)
Galvaniz	Dakromet		
CS M8	CS M8 D	M8X15	0,012

Used with 4 sets of CS M8 Bolt & Nuts each

H:40 Yatay Seviye Değişirme / H:40 Horizontal Adjustable Connector

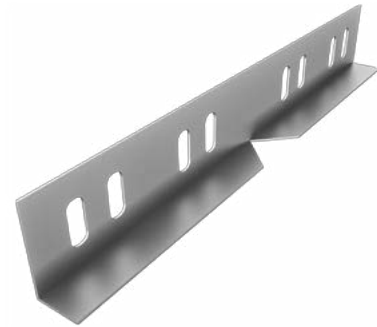
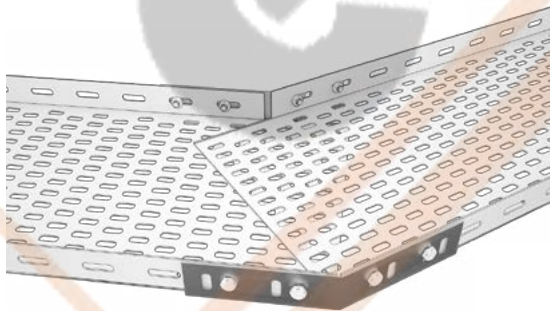

H:40 YATAY SEVİYE DEĞİŞTİRME / H:40 HORIZONTAL ADJUSTABLE CONNECTOR

Ürün Kodu / Product Code		(H) Yükseklik Height (mm)	(T) Kalınlık Thickness (mm)	Ürt. Ağırlık Mnf. Weight (kg/adet)
Pregalvaniz (PG)	Sıcak Daldırma (HDG)			
EK SHA 40-12 PG	EK SHA 40-12 HDG	40	1,20	0,14
EK SHA 40-15 PG	EK SHA 40-15 HDG	40	1,50	0,17
EK SHA 40-20 PG	EK SHA 40-20 HDG	40	2,00	0,23

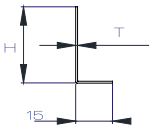

Used with 4 sets of CS M8 Bolt & Nuts each

H:40 90 Derece Dönüş Elemanı / H:40 Horizontal 90 Degree Bend

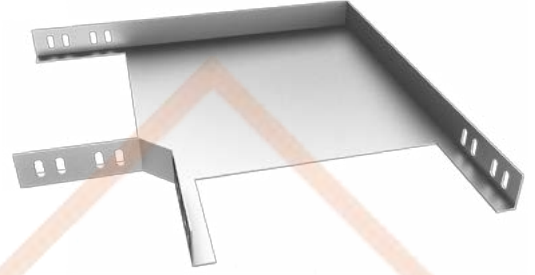

H:40 90 DERECE DÖNÜŞ ELEMANLARI / H:40 HORIZONTAL 90 DEGREE BENDS

Ürün Kodu / Product Code		(W) En Width (mm)	(H) Yükseklik Height (mm)	(T) Kalınlık Thickness (mm)	Ürt. Ağırlık Mnf. Weight (kg/adet)
Pregalvaniz (PG)	Sıcak Daldırma (HDG)				
EK K90 50-40 PG	EK K90 50-40 HDG	50	40	1,50	0,60
EK K90 70-40 PG	EK K90 70-40 HDG	70	40	1,50	0,79
EK K90 100-40 PG	EK K90 100-40 HDG	100	40	1,50	0,81
EK K90 120-40 PG	EK K90 120-40 HDG	120	40	1,50	1,09
EK K90 160-40 PG	EK K90 160-40 HDG	160	40	1,50	1,12
EK K90 200-40 PG	EK K90 200-40 HDG	200	40	1,50	1,41
EK K90 260-40 PG	EK K90 260-40 HDG	260	40	1,50	1,81
EK K90 300-40 PG	EK K90 300-40 HDG	300	40	2,00	2,99
EK K90 400-40 PG	EK K90 400-40 HDG	400	40	2,00	4,24
EK K90 500-40 PG	EK K90 500-40 HDG	500	40	2,00	6,17
EK K90 600-40 PG	EK K90 600-40 HDG	600	40	2,00	8,22

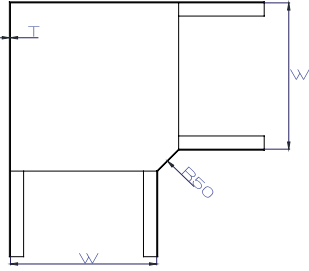

Radius 50

Used with 8 sets of CS M8 Bolt & Nuts each

H:40 T Dönüş Elemanı / H:40 Horizontal Tee Bend

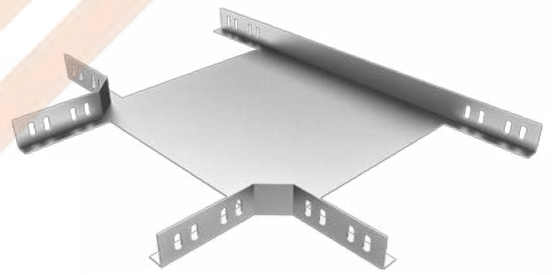
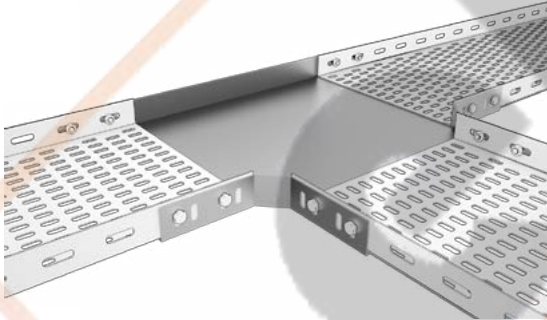

H:40 T DÖNÜŞ ELEMANLARI / H:40 HORIZONTAL TEE BENDS

Ürün Kodu / Product Code		(W) En Width (mm)	(H) Yükseklik Height (mm)	(T) Kalınlık Thickness (mm)	Ürt. Ağırlık Mnf. Weight (kg/adet)
Pregalvaniz (PG)	Sıcak Daldırma (HDG)				
EK KT 50-40 PG	EK KT 50-40 HDG	50	40	1,50	0,83
EK KT 70-40 PG	EK KT 70-40 HDG	70	40	1,50	1,01
EK KT 100-40 PG	EK KT 100-40 HDG	100	40	1,50	1,05
EK KT 120-40 PG	EK KT 120-40 HDG	120	40	1,50	1,29
EK KT 160-40 PG	EK KT 160-40 HDG	160	40	1,50	1,39
EK KT 200-40 PG	EK KT 200-40 HDG	200	40	1,50	1,63
EK KT 260-40 PG	EK KT 260-40 HDG	260	40	1,50	2,16
EK KT 300-40 PG	EK KT 300-40 HDG	300	40	2,00	3,28
EK KT 400-40 PG	EK KT 400-40 HDG	400	40	2,00	4,70
EK KT 500-40 PG	EK KT 500-40 HDG	500	40	2,00	6,43
EK KT 600-40 PG	EK KT 600-40 HDG	600	40	2,00	8,48

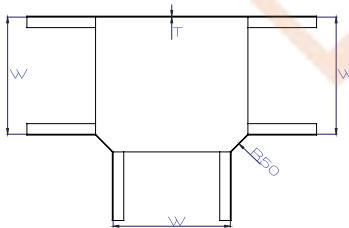

Radius 50

Used with 12 sets of CS M8 Bolt & Nuts each

H:40 Dörtlü Bağlantı Dönüş Elemanı / H:40 Horizontal Crossing

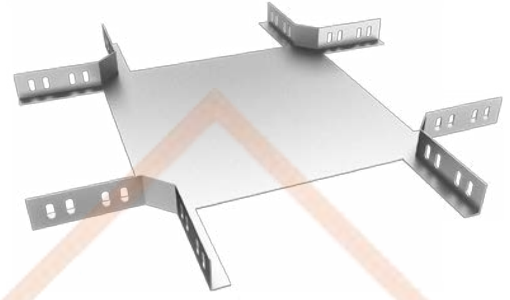
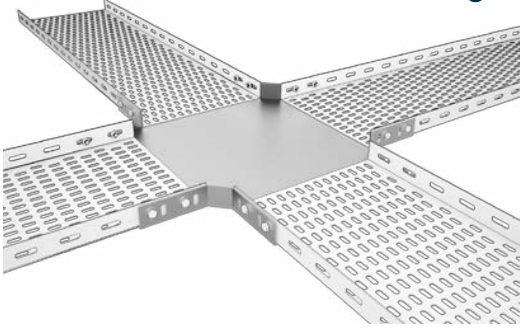

H:40 DÖRTLÜ BAĞLANTI DÖNÜŞ ELEMANLARI / H:40 HORIZONTAL CROSSINGS

Ürün Kodu / Product Code		(W) En Width	(H) Yükseklik Height	(T) Kalınlık Thickness	Ürt. Ağırlık Mnf. Weight
Pregalvaniz (PG)	Sıcak Daldırma (HDG)	(mm)	(mm)	(mm)	(kg/adet)
EK KC 50-40 PG	EK KC 50-40 HDG	50	40	1,50	1,08
EK KC 70-40 PG	EK KC 70-40 HDG	70	40	1,50	1,25
EK KC 100-40 PG	EK KC 100-40 HDG	100	40	1,50	1,27
EK KC 120-40 PG	EK KC 120-40 HDG	120	40	1,50	1,51
EK KC 160-40 PG	EK KC 160-40 HDG	160	40	1,50	1,55
EK KC 200-40 PG	EK KC 200-40 HDG	200	40	1,50	1,86
EK KC 260-40 PG	EK KC 260-40 HDG	260	40	1,50	2,24
EK KC 300-40 PG	EK KC 300-40 HDG	300	40	2,00	3,57
EK KC 400-40 PG	EK KC 400-40 HDG	400	40	2,00	4,98
EK KC 500-40 PG	EK KC 500-40 HDG	500	40	2,00	6,71
EK KC 600-40 PG	EK KC 600-40 HDG	600	40	2,00	8,74

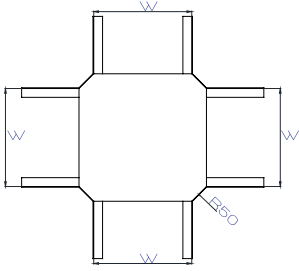

Radius 50

Used with 16 sets of CS M8 Bolt & Nuts each

H:40 45 Derece Dönüş Elemanı / H:40 Horizontal 45 Degree Bend

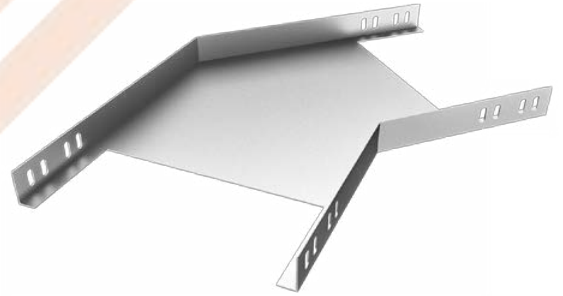

H:40 45 DERECE DÖNÜŞ ELEMANLARI / H:40 HORIZONTAL 45 DEGREE BENDS

Ürün Kodu / Product Code		(W) En Width	(H) Yükseklik Height	(T) Kalınlık Thickness	Ürt. Ağırlık Mnf. Weight
Pregalvaniz (PG)	Sıcak Daldırma (HDG)	(mm)	(mm)	(mm)	(kg/adet)
EK K45 50-40 PG	EK K45 50-40 HDG	50	40	1,50	0,89
EK K45 70-40 PG	EK K45 70-40 HDG	70	40	1,50	1,07
EK K45 100-40 PG	EK K45 100-40 HDG	100	40	1,50	1,11
EK K45 120-40 PG	EK K45 120-40 HDG	120	40	1,50	1,35
EK K45 160-40 PG	EK K45 160-40 HDG	160	40	1,50	1,38
EK K45 200-40 PG	EK K45 200-40 HDG	200	40	1,50	1,67
EK K45 260-40 PG	EK K45 260-40 HDG	260	40	1,50	2,02
EK K45 300-40 PG	EK K45 300-40 HDG	300	40	2,00	3,01
EK K45 400-40 PG	EK K45 400-40 HDG	400	40	2,00	4,39
EK K45 500-40 PG	EK K45 500-40 HDG	500	40	2,00	5,81
EK K45 600-40 PG	EK K45 600-40 HDG	600	40	2,00	7,45

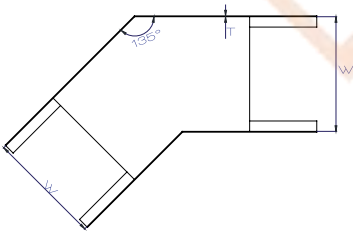

Used with 8 sets of CS M8 Bolt & Nuts each

H:40 Dış Bükey Dönüş Elemanı / H:40 Vertical Outside Bend

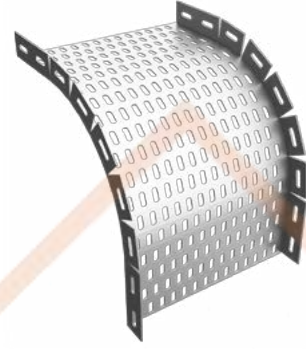

H:40 DIŞ BÜKEY DÖNÜŞ ELEMANLARI / H:40 VERTICAL OUTSIDE BENDS

Ürün Kodu / Product Code		(W) En Width	(H) Yükseklik Height	(T) Kalınlık Thickness	Ürt. Ağırlık Mnf. Weight
Pregalvaniz (PG)	Sıcak Daldırma (HDG)	(mm)	(mm)	(mm)	(kg/adet)
EK KDB 50-40 PG	EK KDB 50-40 HDG	50	40	1,00	0,67
EK KDB 70-40 PG	EK KDB 70-40 HDG	70	40	1,00	0,78
EK KDB 100-40 PG	EK KDB 100-40 HDG	100	40	1,20	1,12
EK KDB 120-40 PG	EK KDB 120-40 HDG	120	40	1,20	1,24
EK KDB 160-40 PG	EK KDB 160-40 HDG	160	40	1,20	1,50
EK KDB 200-40 PG	EK KDB 200-40 HDG	200	40	1,50	2,18
EK KDB 260-40 PG	EK KDB 260-40 HDG	260	40	1,50	2,64
EK KDB 300-40 PG	EK KDB 300-40 HDG	300	40	2,00	3,94
EK KDB 400-40 PG	EK KDB 400-40 HDG	400	40	2,00	6,23
EK KDB 500-40 PG	EK KDB 500-40 HDG	500	40	2,00	7,51
EK KDB 600-40 PG	EK KDB 600-40 HDG	600	40	2,00	8,81

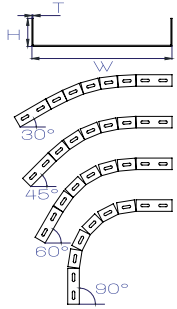

Used with 4 connectors & 8 sets of CS M8 Bolt & Nuts each

Vertical Bend delivered in plain position & may be used for 30-90 degree bendings

H:40 İç Bükey Dönüş Elemanı / H:40 Vertical Inside Bend

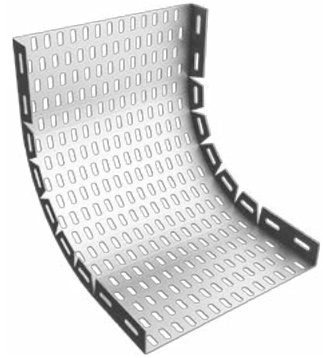
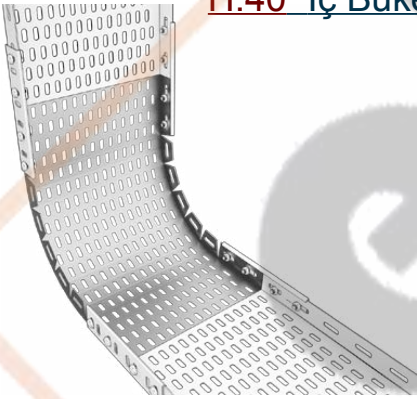

H:40 İÇ BÜKEY DÖNÜŞ ELEMANLARI / H:40 VERTICAL INSIDE BENDS

Ürün Kodu / Product Code		(W) En Width	(H) Yükseklik Height	(T) Kalınlık Thickness	Ürt. Ağırlık Mnf. Weight
Pregalvaniz (PG)	Sıcak Daldırma (HDG)	(mm)	(mm)	(mm)	(kg/adet)
EK KIB 50-40 PG	EK KIB 50-40 HDG	50	40	1,00	0,67
EK KIB 70-40 PG	EK KIB 70-40 HDG	70	40	1,00	0,78
EK KIB 100-40 PG	EK KIB 100-40 HDG	100	40	1,20	1,12
EK KIB 120-40 PG	EK KIB 120-40 HDG	120	40	1,20	1,24
EK KIB 160-40 PG	EK KIB 160-40 HDG	160	40	1,20	1,50
EK KIB 200-40 PG	EK KIB 200-40 HDG	200	40	1,50	2,18
EK KIB 260-40 PG	EK KIB 260-40 HDG	260	40	1,50	2,64
EK KIB 300-40 PG	EK KIB 300-40 HDG	300	40	2,00	3,94
EK KIB 400-40 PG	EK KIB 400-40 HDG	400	40	2,00	6,23
EK KIB 500-40 PG	EK KIB 500-40 HDG	500	40	2,00	7,51
EK KIB 600-40 PG	EK KIB 600-40 HDG	600	40	2,00	8,81

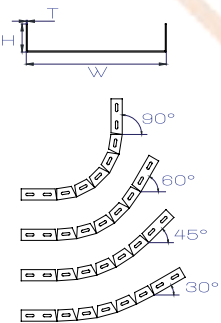

Used with 4 connectors & 8 sets of CS M8 Bolt & Nuts each

Vertical Bend delivered in plain position & may be used for 30-90 degree bendings



H:40 Redüksiyon Elemanı ( Orta ) / H:40 Middle Reducer Connector Set

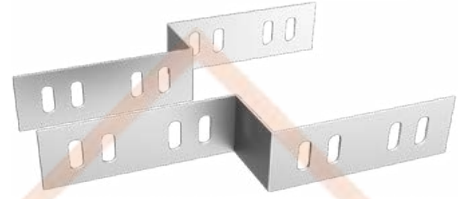
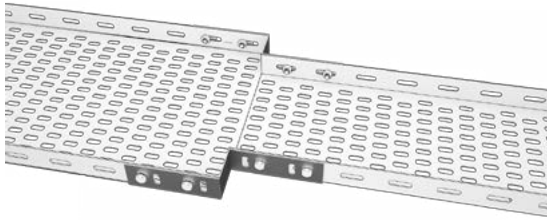

H:40 REDÜKSİYON ELEMANLARI ( ORTA ) / H:40 MIDDLE REDUCER CONNECTOR SET

Ürün Kodu / Product Code		(A) Ara Reduction	(H) Yükseklik Height	(T) Kalınlık Thickness	Ürt. Ağırlık Mnf. Weight
Pregalvaniz (PG)	Sıcak Daldırma (HDG)	(mm)	(mm)	(mm)	(kg/adet)
EK RO 40-40 PG	EK RO 40-40 HDG	40	40	1,50	0,25
EK RO 50-40 PG	EK RO 50-40 HDG	50	40	1,50	0,26
EK RO 60-40 PG	EK RO 60-40 HDG	60	40	1,50	0,27
EK RO 80-40 PG	EK RO 80-40 HDG	80	40	1,50	0,28
EK RO 100-40 PG	EK RO 100-40 HDG	100	40	1,50	0,29
EK RO 160-40 PG	EK RO 160-40 HDG	160	40	1,50	0,31
EK RO 200-40 PG	EK RO 200-40 HDG	200	40	1,50	0,33
EK RO 300-40 PG	EK RO 300-40 HDG	300	40	1,50	0,38
EK RO 400-40 PG	EK RO 400-40 HDG	400	40	1,50	0,43
EK RO 500-40 PG	EK RO 500-40 HDG	500	40	1,50	0,48

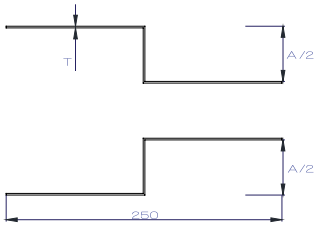

Used with 8 sets of CS M8 Bolt & Nuts each

H:40 Redüksiyon Elemanı ( Sol ) / H:40 Left Reducer Connector Set

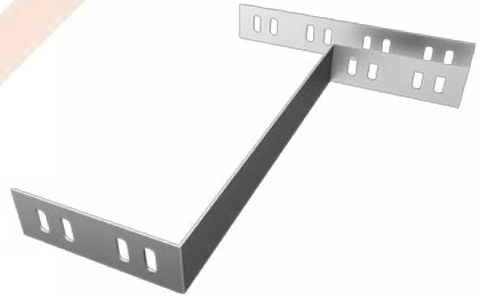
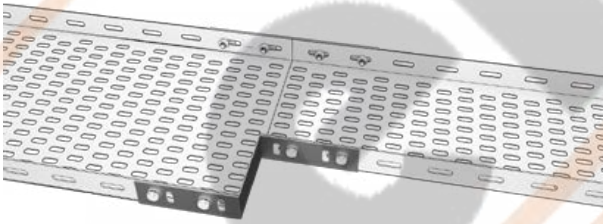

H:40 REDÜKSİYON ELEMANLARI ( SOL ) / H:40 LEFT REDUCER CONNECTOR SET

Ürün Kodu / Product Code		(A) Ara Reduction	(H) Yükseklik Height	(T) Kalınlık Thickness	Ürt. Ağırlık Mnf. Weight
Pregalvaniz (PG)	Sıcak Daldırma (HDG)	(mm)	(mm)	(mm)	(kg/adet)
EK RL 40-40 PG	EK RL 40-40 HDG	40	40	1,50	0,25
EK RL 50-40 PG	EK RL 50-40 HDG	50	40	1,50	0,26
EK RL 60-40 PG	EK RL 60-40 HDG	60	40	1,50	0,27
EK RL 80-40 PG	EK RL 80-40 HDG	80	40	1,50	0,28
EK RL 100-40 PG	EK RL 100-40 HDG	100	40	1,50	0,29
EK RL 160-40 PG	EK RL 160-40 HDG	160	40	1,50	0,31
EK RL 200-40 PG	EK RL 200-40 HDG	200	40	1,50	0,33
EK RL 300-40 PG	EK RL 300-40 HDG	300	40	1,50	0,38
EK RL 400-40 PG	EK RL 400-40 HDG	400	40	1,50	0,43
EK RL 500-40 PG	EK RL 500-40 HDG	500	40	1,50	0,48

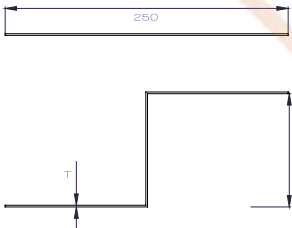

Used with 8 sets of CS M8 Bolt & Nuts each

H:40 Redüksiyon Elemanı ( Sağ ) / H:40 Right Reducer Connector Set

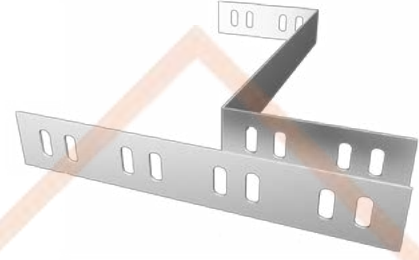
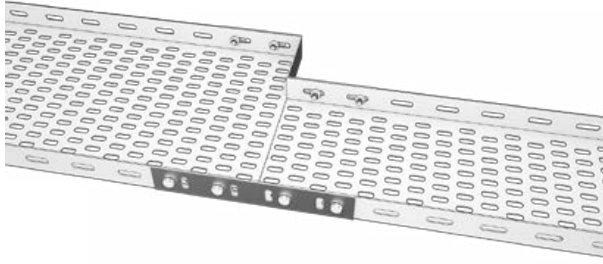

H:40 REDÜKSİYON ELEMANLARI ( SAĞ ) / H:40 RIGHT REDUCER CONNECTOR SET

Ürün Kodu / Product Code		(A) Ara Reduction	(H) Yükseklik Height	(T) Kalınlık Thickness	Ürt. Ağırlık Mnf. Weight
Pregalvaniz (PG)	Sıcak Daldırma (HDG)	(mm)	(mm)	(mm)	(kg/adet)
EK RR 40-40 PG	EK RR 40-40 HDG	40	40	1,50	0,25
EK RR 50-40 PG	EK RR 50-40 HDG	50	40	1,50	0,26
EK RR 60-40 PG	EK RR 60-40 HDG	60	40	1,50	0,27
EK RR 80-40 PG	EK RR 80-40 HDG	80	40	1,50	0,28
EK RR 100-40 PG	EK RR 100-40 HDG	100	40	1,50	0,29
EK RR 160-40 PG	EK RR 160-40 HDG	160	40	1,50	0,31
EK RR 200-40 PG	EK RR 200-40 HDG	200	40	1,50	0,33
EK RR 300-40 PG	EK RR 300-40 HDG	300	40	1,50	0,38
EK RR 400-40 PG	EK RR 400-40 HDG	400	40	2,00	0,43
EK RR 500-40 PG	EK RR 500-40 HDG	500	40	2,00	0,48

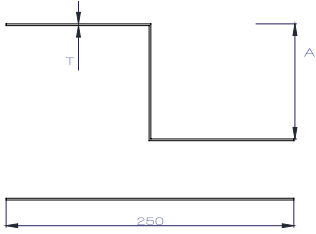

Used with 8 sets of CS M8 Bolt & Nuts each

H:40 Separatör / H:40 Separator

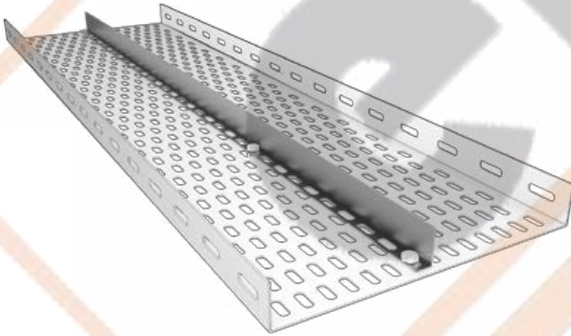

H:40 SEPERATÖR / H:40 SEPARATOR

Ürün Kodu / Product Code		(H) Yükseklik Height	(T) Kalınlık Thickness	Ürt. Ağırlık Mnf. Weight
Pregalvaniz (PG)	Sıcak Daldırma (HDG)	(mm)	(mm)	(kg/adet)
EK SEP 40-10 PG	EK SEP 40-10 HDG	40	1,00	0,43
EK SEP 40-12 PG	EK SEP 40-12 HDG	40	1,20	0,52
EK SEP 40-15 PG	EK SEP 40-15 HDG	40	1,50	0,65

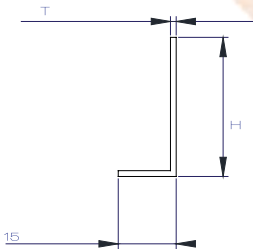

Used with CS M8 Bolt & Nuts

H:40 Sonlandırma / H:40 Stopend

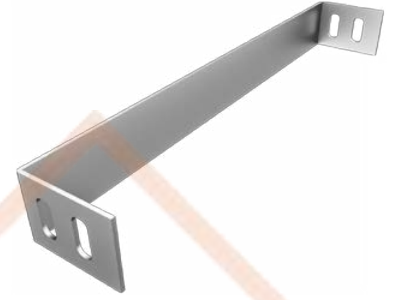
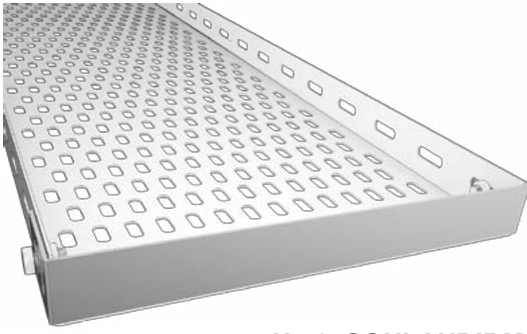

H:40 SONLANDIRMA / H:40 STOPENDS

Ürün Kodu / Product Code		(W) En Width	(H) Yükseklik Height	(T) Kalınlık Thickness	Ürt. Ağırlık Mnf. Weight
Pregalvaniz (PG)	Sıcak Daldırma (HDG)	(mm)	(mm)	(mm)	(kg/adet)
EK SON 50-40 PG	EK SON 50-40 HDG	50	40	1,50	0,14
EK SON 70-40 PG	EK SON 70-40 HDG	70	40	1,50	0,16
EK SON 100-40 PG	EK SON 100-40 HDG	100	40	1,50	0,17
EK SON 120-40 PG	EK SON 120-40 HDG	120	40	1,50	0,18
EK SON 160-40 PG	EK SON 160-40 HDG	160	40	1,50	0,19
EK SON 200-40 PG	EK SON 200-40 HDG	200	40	1,50	0,21
EK SON 260-40 PG	EK SON 260-40 HDG	260	40	1,50	0,24
EK SON 300-40 PG	EK SON 300-40 HDG	300	40	2,00	0,35
EK SON 400-40 PG	EK SON 400-40 HDG	400	40	2,00	0,41
EK SON 500-40 PG	EK SON 500-40 HDG	500	40	2,00	0,47
EK SON 600-40 PG	EK SON 600-40 HDG	600	40	2,00	0,54

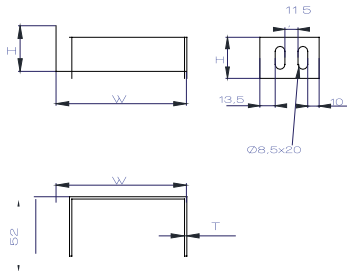

Used with 2 sets of CS M8 Bolt & Nuts

H:40 Dikey Seviye Değişirme / H:40 Vertical Adjustable Connector

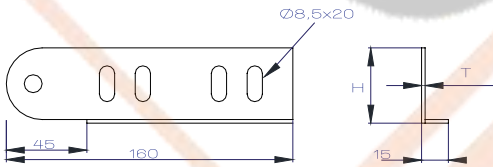
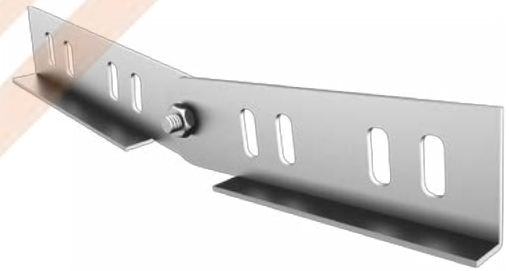
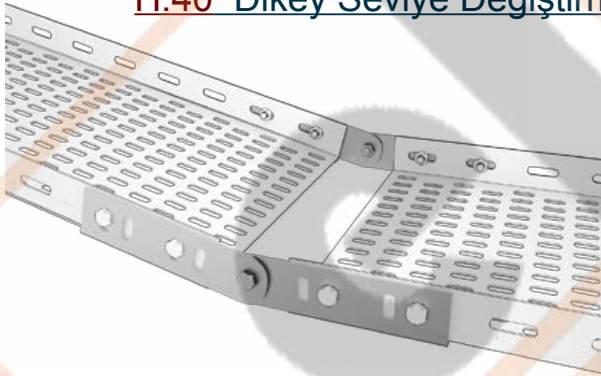

H:40 DİKEY SEVİYE DEĞİŞTİRME / H:40 VERTICAL ADJUSTABLE CONNECTOR

Ürün Kodu		(H) Yükseklik Height	(T) Kalınlık Thickness	Ürt. Ağırlık Mnf. Weight
Pregalvaniz (PG)	Sıcak Daldırma (HDG)	(mm)	(mm)	(kg/adet)
EK SVA 40-12 PG	EK SVA 40-12 HDG	40	1,20	0,19
EK SVA 40-15 PG	EK SVA 40-15 HDG	40	1,50	0,24
EK SVA 40-20 PG	EK SVA 40-20 HDG	40	2,00	0,32

Used with 8 sets of CS M8 Bolt & Nuts each

**H:50 KABLO KANALLARI**  
**H:50 CABLE TRAYS**

# H:50 STANDART DELİKLİ KABLO KANALLARI

## H:50 STANDARD PERFORATED CABLE TRAYS

**el-ka**

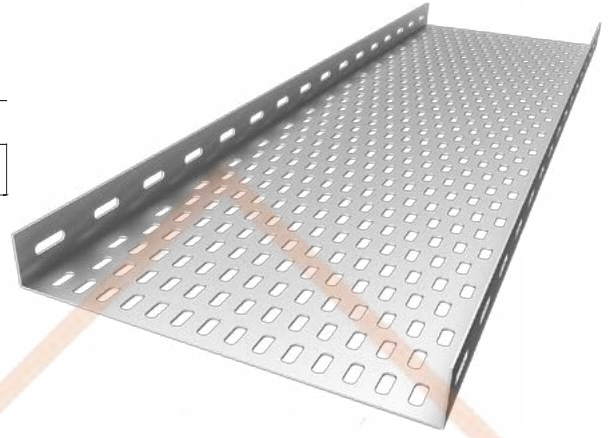
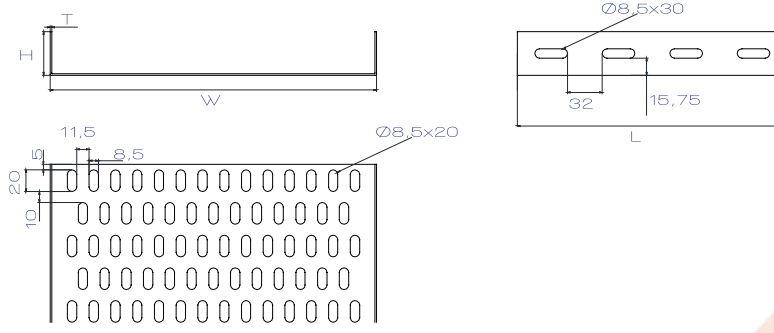

### H:50 STANDART DELİKLİ KABLO KANALLARI / H:50 STANDARD PERFORATED CABLE TRAYS

Ürün Kodu / Product Code		(W) En Width (mm)	(H) Yükseklik Height (mm)	(T) Kalınlık Thickness (mm)	Ürt. Ağırlık Mnf. Weight (kg/mt)	(L) Boy Length (mm)
Pregalvaniz (PG)	Sıcak Daldırma (HDG)					
EK SPK 50-50-08 PG	-	50	50	0,80	0,94	2500
EK SPK 50-50-10 PG	EK SPK 50-50-10 HDG	50	50	1,00	1,18	2500
EK SPK 50-50-12 PG	EK SPK 50-50-12 HDG	50	50	1,20	1,41	2500
EK SPK 50-50-15 PG	EK SPK 50-50-15 HDG	50	50	1,50	1,77	2500
EK SPK 70-50-08 PG	-	70	50	0,80	1,07	2500
EK SPK 70-50-10 PG	EK SPK 70-50-10 HDG	70	50	1,00	1,33	2500
EK SPK 70-50-12 PG	EK SPK 70-50-12 HDG	70	50	1,20	1,60	2500
EK SPK 70-50-15 PG	EK SPK 70-50-15 HDG	70	50	1,50	2,00	2500
EK SPK 100-50-08 PG	-	100	50	0,80	1,26	2500
EK SPK 100-50-10 PG	EK SPK 100-50-10 HDG	100	50	1,00	1,57	2500
EK SPK 100-50-12 PG	EK SPK 100-50-12 HDG	100	50	1,20	1,88	2500
EK SPK 100-50-15 PG	EK SPK 100-50-15 HDG	100	50	1,50	2,36	2500
EK SPK 120-50-10 PG	EK SPK 120-50-10 HDG	120	50	1,00	1,73	2500
EK SPK 120-50-12 PG	EK SPK 120-50-12 HDG	120	50	1,20	2,07	2500
EK SPK 120-50-15 PG	EK SPK 120-50-15 HDG	120	50	1,50	2,59	2500
EK SPK 160-50-10 PG	EK SPK 160-50-10 HDG	160	50	1,00	2,04	2500
EK SPK 160-50-12 PG	EK SPK 160-50-12 HDG	160	50	1,20	2,45	2500
EK SPK 160-50-15 PG	EK SPK 160-50-15 HDG	160	50	1,50	3,06	2500
EK SPK 200-50-10 PG	-	200	50	1,00	2,36	2500
EK SPK 200-50-12 PG	-	200	50	1,20	2,83	2500
EK SPK 200-50-15 PG	EK SPK 200-50-15 HDG	200	50	1,50	3,53	2500
EK SPK 200-50-20 PG	EK SPK 200-50-20 HDG	200	50	2,00	4,71	2500
EK SPK 260-50-12 PG	EK SPK 260-50-12 HDG	260	50	1,20	3,39	2500
EK SPK 260-50-15 PG	EK SPK 260-50-15 HDG	260	50	1,50	4,24	2500
EK SPK 260-50-20 PG	EK SPK 260-50-20 HDG	260	50	2,00	5,65	2500
EK SPK 300-50-12 PG	-	300	50	1,20	3,77	2500
EK SPK 300-50-15 PG	EK SPK 300-50-15 HDG	300	50	1,50	4,71	2500
EK SPK 300-50-20 PG	EK SPK 300-50-20 HDG	300	50	2,00	6,28	2500
EK SPK 400-50-12 PG	-	400	50	1,20	4,71	2500
EK SPK 400-50-15 PG	EK SPK 400-50-15 HDG	400	50	1,50	5,89	2500
EK SPK 400-50-20 PG	EK SPK 400-50-20 HDG	400	50	2,00	7,85	2500
EK SPK 500-50-15 PG	EK SPK 500-50-15 HDG	500	50	1,50	7,07	2500
EK SPK 500-50-20 PG	EK SPK 500-50-20 HDG	500	50	2,00	9,42	2500
EK SPK 600-50-15 PG	EK SPK 600-50-15 HDG	600	50	1,50	8,24	2500
EK SPK 600-50-20 PG	EK SPK 600-50-20 HDG	600	50	2,00	10,99	2500

H:50 Standard Cable Tray Load Graph

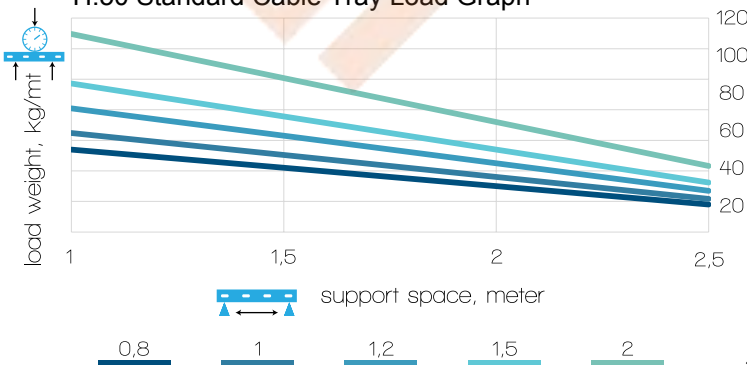

Permissible loads for a maximum deflection of 1/100th of the span, with coupling positioned at 1/5th of the span from support. The coefficient applied to the load for coupling in the middle of the span: 0.7  
Safety co-efficient: 1.7  
Recommended support distance: 1.5mt

Güvenlik katsayısı: 1,7  
Tavsiye edilen destek konsol aralığı: 1,5mt

# H:50 STANDART DELİKSİZ KABLO KANALLARI

## H:50 STANDARD NON-PERFORATED CABLE TRAYS

**el-ka**

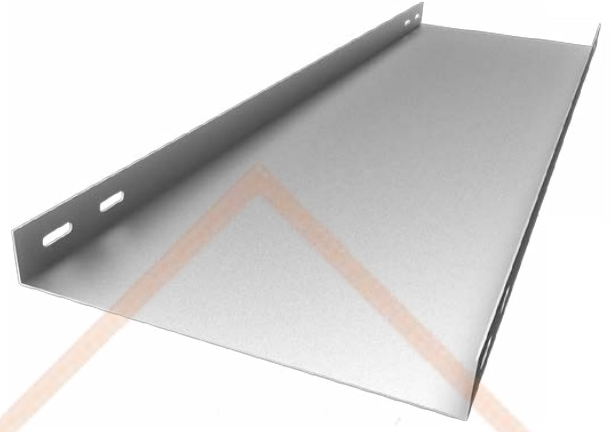
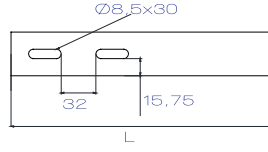
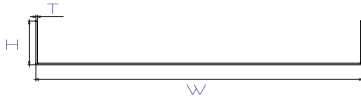

### H:50 STANDART DELİKSİZ KABLO KANALLARI / H:40 STANDARD NON-PERFORATED CABLE TRAYS

Ürün Kodu / Product Code		(W) En Width	(H) Yükseklik Height	(T) Kalınlık Thickness	Ürt. Ağırlık Mnf. Weight	(L) Boy Length
Pregalvaniz (PG)	Sıcak Daldırma (HDG)	(mm)	(mm)	(mm)	(kg/mt)	(mm)
EK SDK 50-50-08 PG	-	50	50	0,80	0,94	2500
EK SDK 50-50-10 PG	EK SDK 50-50-10 HDG	50	50	1,00	1,18	2500
EK SDK 50-50-12 PG	EK SDK 50-50-12 HDG	50	50	1,20	1,41	2500
EK SDK 50-50-15 PG	EK SDK 50-50-15 HDG	50	50	1,50	1,77	2500
EK SDK 70-50-08 PG	-	70	50	0,80	1,07	2500
EK SDK 70-50-10 PG	EK SDK 70-50-10 HDG	70	50	1,00	1,33	2500
EK SDK 70-50-12 PG	EK SDK 70-50-12 HDG	70	50	1,20	1,60	2500
EK SDK 70-50-15 PG	EK SDK 70-50-15 HDG	70	50	1,50	2,00	2500
EK SDK 100-50-08 PG	-	100	50	0,80	1,26	2500
EK SDK 100-50-10 PG	EK SDK 100-50-10 HDG	100	50	1,00	1,57	2500
EK SDK 100-50-12 PG	EK SDK 100-50-12 HDG	100	50	1,20	1,88	2500
EK SDK 100-50-15 PG	EK SDK 100-50-15 HDG	100	50	1,50	2,36	2500
EK SDK 120-50-10 PG	EK SDK 120-50-10 HDG	120	50	1,00	1,73	2500
EK SDK 120-50-12 PG	EK SDK 120-50-12 HDG	120	50	1,20	2,07	2500
EK SDK 120-50-15 PG	EK SDK 120-50-15 HDG	120	50	1,50	2,59	2500
EK SDK 160-50-10 PG	EK SDK 160-50-10 HDG	160	50	1,00	2,04	2500
EK SDK 160-50-12 PG	EK SDK 160-50-12 HDG	160	50	1,20	2,45	2500
EK SDK 160-50-15 PG	EK SDK 160-50-15 HDG	160	50	1,50	3,06	2500
EK SDK 200-50-10 PG	-	200	50	1,00	2,36	2500
EK SDK 200-50-12 PG	-	200	50	1,20	2,83	2500
EK SDK 200-50-15 PG	EK SDK 200-50-15 HDG	200	50	1,50	3,53	2500
EK SDK 200-50-20 PG	EK SDK 200-50-20 HDG	200	50	2,00	4,71	2500
EK SDK 260-50-12 PG	EK SDK 260-50-12 HDG	260	50	1,20	3,39	2500
EK SDK 260-50-15 PG	EK SDK 260-50-15 HDG	260	50	1,50	4,24	2500
EK SDK 260-50-20 PG	EK SDK 260-50-20 HDG	260	50	2,00	5,65	2500
EK SDK 300-50-12 PG	-	300	50	1,20	3,77	2500
EK SDK 300-50-15 PG	EK SDK 300-50-15 HDG	300	50	1,50	4,71	2500
EK SDK 300-50-20 PG	EK SDK 300-50-20 HDG	300	50	2,00	6,28	2500
EK SDK 400-50-12 PG	-	400	50	1,20	4,71	2500
EK SDK 400-50-15 PG	EK SDK 400-50-15 HDG	400	50	1,50	5,89	2500
EK SDK 400-50-20 PG	EK SDK 400-50-20 HDG	400	50	2,00	7,85	2500
EK SDK 500-50-15 PG	EK SDK 500-50-15 HDG	500	50	1,50	7,07	2500
EK SDK 500-50-20 PG	EK SDK 500-50-20 HDG	500	50	2,00	9,42	2500
EK SDK 600-50-15 PG	EK SDK 600-50-15 HDG	600	50	1,50	8,24	2500
EK SDK 600-50-20 PG	EK SDK 600-50-20 HDG	600	50	2,00	10,99	2500

H:50 Standard Cable Tray Load Graph

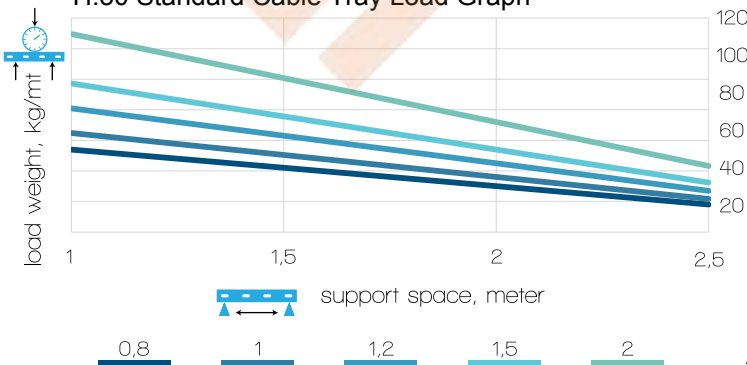

Permissible loads for a maximum deflection of 1/100th of the span, with coupling positioned at 1/5th of the span from support. The coefficient applied to the load for coupling in the middle of the span: 0.7

Safety co-efficient: 1.7

Recommended support distance: 1.5mt

Güvenlik katsayısı: 1,7

Tavsiye edilen destek konsol aralığı: 1,5mt

# H:50 AĞIR HİZMET DELİKLİ KABLO KANALLARI H:50 HEAVY DUTY PERFORATED CABLE TRAYS

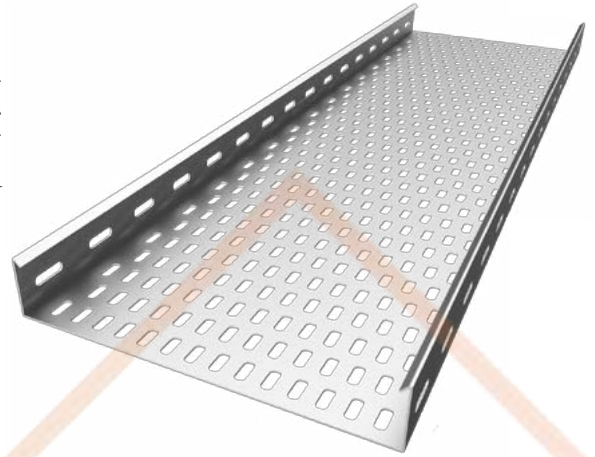
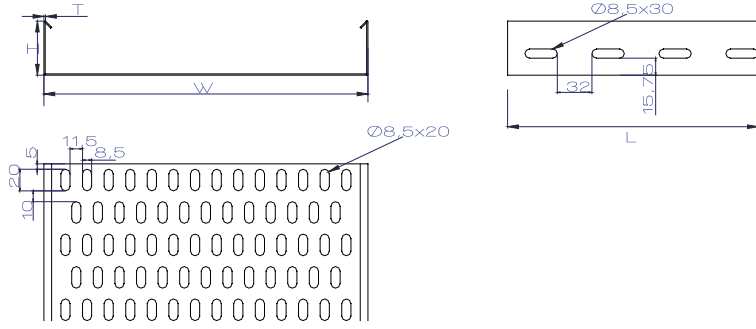

## H:50 AĞIR HİZMET DELİKLİ KABLO KANALLARI / H:50 HEAVY DUTY PERFORATED CABLE TRAYS

Ürün Kodu / Product Code		(W) En Width (mm)	(H) Yükseklik Height (mm)	(T) Kalınlık Thickness (mm)	Ürt. Ağırlık Mnf. Weight (kg/mt)	(L) Boy Length (mm)
Pregalvaniz (PG)	Sıcak Daldırma (HDG)					
EK APK 50-50-08 PG	-	50	50	0,80	1,07	2500
EK APK 50-50-10 PG	EK APK 50-50-10 HDG	50	50	1,00	1,33	2500
EK APK 50-50-12 PG	EK APK 50-50-12 HDG	50	50	1,20	1,60	2500
EK APK 50-50-15 PG	EK APK 50-50-15 HDG	50	50	1,50	2,00	2500
EK APK 70-50-08 PG	-	70	50	0,80	1,19	2500
EK APK 70-50-10 PG	EK APK 70-50-10 HDG	70	50	1,00	1,49	2500
EK APK 70-50-12 PG	EK APK 70-50-12 HDG	70	50	1,20	1,79	2500
EK APK 70-50-15 PG	EK APK 70-50-15 HDG	70	50	1,50	2,24	2500
EK APK 100-50-08 PG	-	100	50	0,80	1,38	2500
EK APK 100-50-10 PG	EK APK 100-50-10 HDG	100	50	1,00	1,73	2500
EK APK 100-50-12 PG	EK APK 100-50-12 HDG	100	50	1,20	2,07	2500
EK APK 100-50-15 PG	EK APK 100-50-15 HDG	100	50	1,50	2,59	2500
EK APK 120-50-10 PG	EK APK 120-50-10 HDG	120	50	1,00	1,88	2500
EK APK 120-50-12 PG	EK APK 120-50-12 HDG	120	50	1,20	2,26	2500
EK APK 120-50-15 PG	EK APK 120-50-15 HDG	120	50	1,50	2,83	2500
EK APK 160-50-10 PG	EK APK 160-50-10 HDG	160	50	1,00	2,20	2500
EK APK 160-50-12 PG	EK APK 160-50-12 HDG	160	50	1,20	2,64	2500
EK APK 160-50-15 PG	EK APK 160-50-15 HDG	160	50	1,50	3,30	2500
EK APK 200-50-10 PG	-	200	50	1,00	2,51	2500
EK APK 200-50-12 PG	-	200	50	1,20	3,01	2500
EK APK 200-50-15 PG	EK APK 200-50-15 HDG	200	50	1,50	3,77	2500
EK APK 200-50-20 PG	EK APK 200-50-20 HDG	200	50	2,00	5,02	2500
EK APK 260-50-12 PG	EK APK 260-50-12 HDG	260	50	1,20	3,58	2500
EK APK 260-50-15 PG	EK APK 260-50-15 HDG	260	50	1,50	4,47	2500
EK APK 260-50-20 PG	EK APK 260-50-20 HDG	260	50	2,00	5,97	2500
EK APK 300-50-12 PG	-	300	50	1,20	3,96	2500
EK APK 300-50-15 PG	EK APK 300-50-15 HDG	300	50	1,50	4,95	2500
EK APK 300-50-20 PG	EK APK 300-50-20 HDG	300	50	2,00	6,59	2500
EK APK 400-50-12 PG	-	400	50	1,20	4,90	2500
EK APK 400-50-15 PG	EK APK 400-50-15 HDG	400	50	1,50	6,12	2500
EK APK 400-50-20 PG	EK APK 400-50-20 HDG	400	50	2,00	8,16	2500
EK APK 500-50-15 PG	EK APK 500-50-15 HDG	500	50	1,50	7,30	2500
EK APK 500-50-20 PG	EK APK 500-50-20 HDG	500	50	2,00	9,73	2500
EK APK 600-50-15 PG	EK APK 600-50-15 HDG	600	50	1,50	8,48	2500
EK APK 600-50-20 PG	EK APK 600-50-20 HDG	600	50	2,00	11,30	2500

H:50 Heavy Duty Cable Tray Load Graph

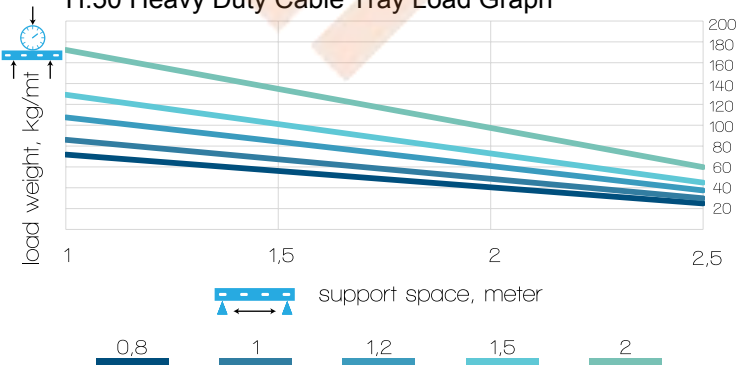

Permissible loads for a maximum deflection of 1/100th of the span, with coupling positioned at 1/5th of the span from support. The coefficient applied to the load for coupling in the middle of the span: 0.7

Safety co-efficient: 1.7

Recommended support distance: 1.5mt

Güvenlik katsayısı: 1,7

Tavsiye edilen destek konsol aralığı: 1,5mt

# H:50 AĞIR HİZMET DELİKSİZ KABLO KANALLARI

## H:50 HEAVY DUTY NON-PERFORATED CABLE TRAYS

**el-ka**

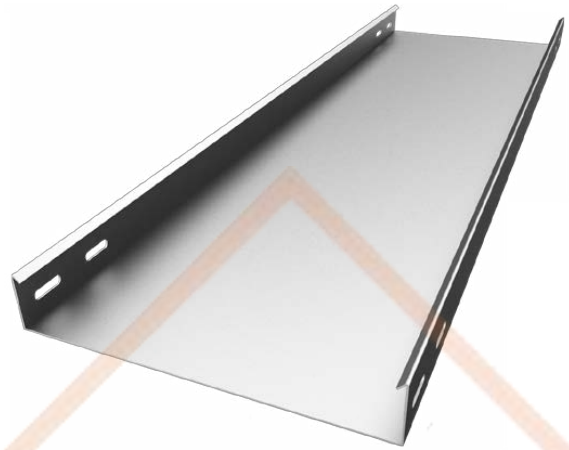
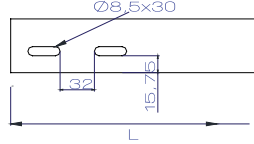
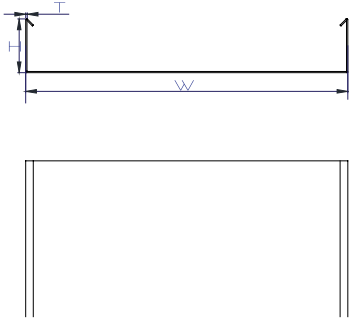

### H:50 AĞIR HİZMET DELİKSİZ KABLO KANALLARI / H:50 HEAVY DUTY NON-PERFORATED CABLE TRAYS

Ürün Kodu / Product Code		(W) En Width (mm)	(H) Yükseklik Height (mm)	(T) Kalınlık Thickness (mm)	Ürt. Ağırlık Mnf. Weight (kg/mt)	(L) Boy Length (mm)
Pregalvaniz (PG)	Sıcak Daldırma (HDG)					
EK ADK 50-50-08 PG	-	50	50	0,80	1,07	2500
EK ADK 50-50-10 PG	EK ADK 50-50-10 HDG	50	50	1,00	1,33	2500
EK ADK 50-50-12 PG	EK ADK 50-50-12 HDG	50	50	1,20	1,60	2500
EK ADK 50-50-15 PG	EK ADK 50-50-15 HDG	50	50	1,50	2,00	2500
EK ADK 70-50-08 PG	-	70	50	0,80	1,19	2500
EK ADK 70-50-10 PG	EK ADK 70-50-10 HDG	70	50	1,00	1,49	2500
EK ADK 70-50-12 PG	EK ADK 70-50-12 HDG	70	50	1,20	1,79	2500
EK ADK 70-50-15 PG	EK ADK 70-50-15 HDG	70	50	1,50	2,24	2500
EK ADK 100-50-08 PG	-	100	50	0,80	1,38	2500
EK ADK 100-50-10 PG	EK ADK 100-50-10 HDG	100	50	1,00	1,73	2500
EK ADK 100-50-12 PG	EK ADK 100-50-12 HDG	100	50	1,20	2,07	2500
EK ADK 100-50-15 PG	EK ADK 100-50-15 HDG	100	50	1,50	2,59	2500
EK ADK 120-50-10 PG	EK ADK 120-50-10 HDG	120	50	1,00	1,88	2500
EK ADK 120-50-12 PG	EK ADK 120-50-12 HDG	120	50	1,20	2,26	2500
EK ADK 120-50-15 PG	EK ADK 120-50-15 HDG	120	50	1,50	2,83	2500
EK ADK 160-50-10 PG	EK ADK 160-50-10 HDG	160	50	1,00	2,20	2500
EK ADK 160-50-12 PG	EK ADK 160-50-12 HDG	160	50	1,20	2,64	2500
EK ADK 160-50-15 PG	EK ADK 160-50-15 HDG	160	50	1,50	3,30	2500
EK ADK 200-50-10 PG	-	200	50	1,00	2,51	2500
EK ADK 200-50-12 PG	-	200	50	1,20	3,01	2500
EK ADK 200-50-15 PG	EK ADK 200-50-15 HDG	200	50	1,50	3,77	2500
EK ADK 200-50-20 PG	EK ADK 200-50-20 HDG	200	50	2,00	5,02	2500
EK ADK 260-50-12 PG	EK ADK 260-50-12 HDG	260	50	1,20	3,58	2500
EK ADK 260-50-15 PG	EK ADK 260-50-15 HDG	260	50	1,50	4,47	2500
EK ADK 260-50-20 PG	EK ADK 260-50-20 HDG	260	50	2,00	5,97	2500
EK ADK 300-50-12 PG	-	300	50	1,20	3,96	2500
EK ADK 300-50-15 PG	EK ADK 300-50-15 HDG	300	50	1,50	4,95	2500
EK ADK 300-50-20 PG	EK ADK 300-50-20 HDG	300	50	2,00	6,59	2500
EK ADK 400-50-12 PG	-	400	50	1,20	4,90	2500
EK ADK 400-50-15 PG	EK ADK 400-50-15 HDG	400	50	1,50	6,12	2500
EK ADK 400-50-20 PG	EK ADK 400-50-20 HDG	400	50	2,00	8,16	2500
EK ADK 500-50-15 PG	EK ADK 500-50-15 HDG	500	50	1,50	7,30	2500
EK ADK 500-50-20 PG	EK ADK 500-50-20 HDG	500	50	2,00	9,73	2500
EK ADK 600-50-15 PG	EK ADK 600-50-15 HDG	600	50	1,50	8,48	2500
EK ADK 600-50-20 PG	EK ADK 600-50-20 HDG	600	50	2,00	11,30	2500

H:50 Heavy Duty Cable Tray Load Graph

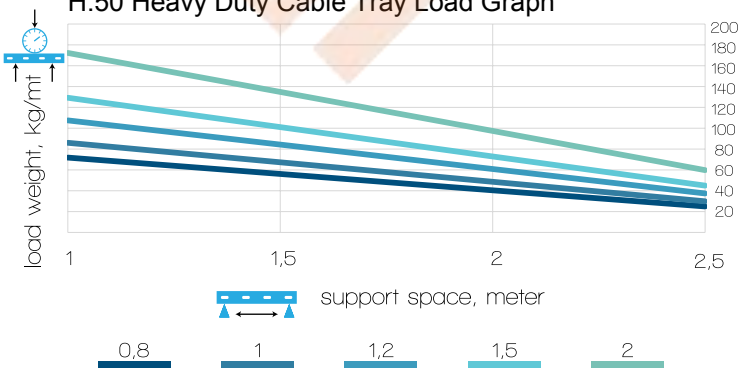

Permissible loads for a maximum deflection of 1/100th of the span, with coupling positioned at 1/5th of the span from support. The coefficient applied to the load for coupling in the middle of the span: 0.7

Safety co-efficient: 1.7

Recommended support distance: 1.5mt

Güvenlik katsayısı: 1,7

Tavsiye edilen destek konsol aralığı: 1,5mt



H:50 Birleştirme Ek Elemanı / H:50 Straight Coupler

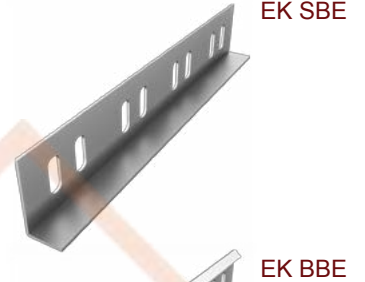
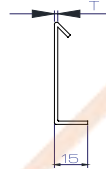
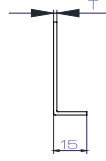
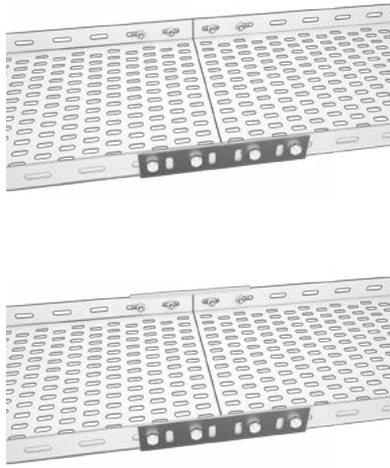

EK SBE

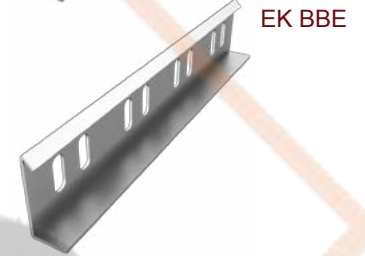

EK BBE

H:50 BİRLEŞTİRME EK ELEMANI / H:50 STRAIGHT CONNECTOR

Ürün Kodu / Product Code		(H) Yükseklik Height (mm)	(T) Kalınlık Thickness (mm)	Ürt. Ağırlık Mnf. Weight (kg/adet)
Pregalvaniz (PG)	Sıcak Daldırma (HDG)			
EK SBE 50-12 PG	EK SBE 50-12 HDG	50	1,20	0,15
EK SBE 50-15 PG	EK SBE 50-15 HDG	50	1,50	0,19
EK BBE 50-12 PG	EK BBE 50-12 HDG	50	1,20	0,17
EK BBE 50-15 PG	EK BBE 50-15 HDG	50	1,50	0,22

M8 CİVATA VE SOMUN / M8 BOLT & NUT



Ürün Kodu / Product Code		Ebat Size (mm)	Ağırlık Weight (kg/adet)
Galvaniz	Dakromet		
CS M8	CS M8 D	M8X15	0,012

Used with 4 sets of CS M8 Bolt & Nuts each

H:50 Yatay Seviye Değişirme / H:50 Horizontal Adjustable Connector

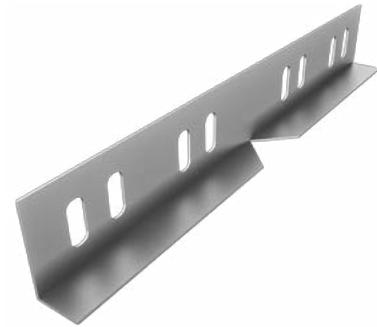
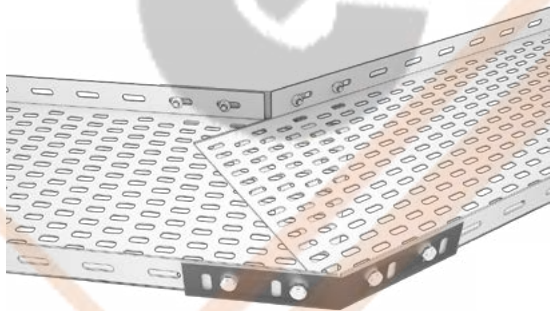

H:50 YATAY SEVİYE DEĞİŞTİRME / H:50 HORIZONTAL ADJUSTABLE CONNECTOR

Ürün Kodu / Product Code		(H) Yükseklik Height (mm)	(T) Kalınlık Thickness (mm)	Ürt. Ağırlık Mnf. Weight (kg/adet)
Pregalvaniz (PG)	Sıcak Daldırma (HDG)			
EK SHA 50-12 PG	EK SHA 50-12 HDG	50	1,20	0,16
EK SHA 50-15 PG	EK SHA 50-15 HDG	50	1,50	0,20
EK SHA 50-20 PG	EK SHA 50-20 HDG	50	2,00	0,27

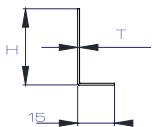

Used with 4 sets of CS M8 Bolt & Nuts each

H:50 90 Derece Dönüş Elemanı / H:50 Horizontal 90 Degree Bend

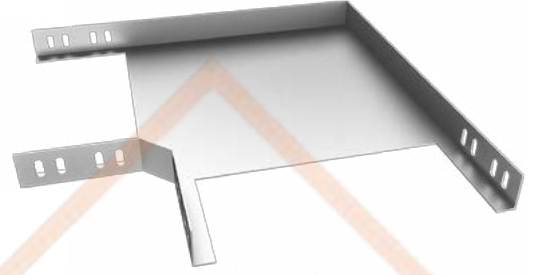

H:50 90 DERECE DÖNÜŞ ELEMANLARI / H:50 HORIZONTAL 90 DEGREE BENDS

Ürün Kodu / Product Code		(W) En Width (mm)	(H) Yükseklik Height (mm)	(T) Kalınlık Thickness (mm)	Ürt. Ağırlık Mnf. Weight (kg/adet)
Pregalvaniz (PG)	Sıcak Daldırma (HDG)				
EK K90 50-50 PG	EK K90 50-50 HDG	50	50	1,50	0,69
EK K90 70-50 PG	EK K90 70-50 HDG	70	50	1,50	0,89
EK K90 100-50 PG	EK K90 100-50 HDG	100	50	1,50	0,92
EK K90 120-50 PG	EK K90 120-50 HDG	120	50	1,50	1,20
EK K90 160-50 PG	EK K90 160-50 HDG	160	50	1,50	1,24
EK K90 200-50 PG	EK K90 200-50 HDG	200	50	1,50	1,54
EK K90 260-50 PG	EK K90 260-50 HDG	260	50	1,50	1,96
EK K90 300-50 PG	EK K90 300-50 HDG	300	50	2,00	3,21
EK K90 400-50 PG	EK K90 400-50 HDG	400	50	2,00	4,49
EK K90 500-50 PG	EK K90 500-50 HDG	500	50	2,00	6,46
EK K90 600-50 PG	EK K90 600-50 HDG	600	50	2,00	8,55

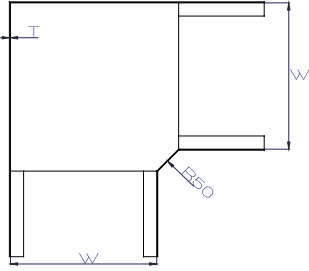

Radius 50

Used with 8 sets of CS M8 Bolt & Nuts each

H:50 T Dönüş Elemanı / H:50 Horizontal Tee Bend

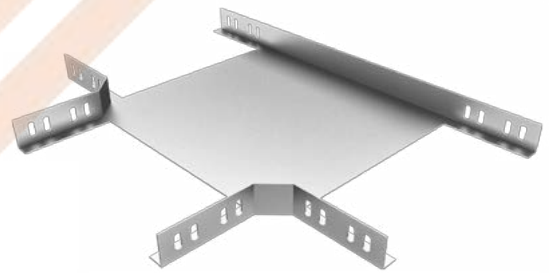
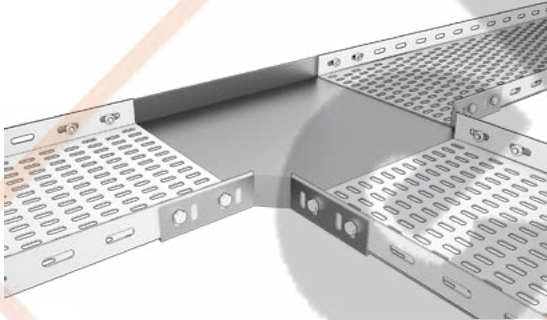

H:50 T DÖNÜŞ ELEMANLARI / H:50 HORIZONTAL TEE BENDS

Ürün Kodu / Product Code		(W) En Width (mm)	(H) Yükseklik Height (mm)	(T) Kalınlık Thickness (mm)	Ürt. Ağırlık Mnf. Weight (kg/adet)
Pregalvaniz (PG)	Sıcak Daldırma (HDG)				
EK KT 50-50 PG	EK KT 50-50 HDG	50	50	1,50	0,96
EK KT 70-50 PG	EK KT 70-50 HDG	70	50	1,50	1,14
EK KT 100-50 PG	EK KT 100-50 HDG	100	50	1,50	1,19
EK KT 120-50 PG	EK KT 120-50 HDG	120	50	1,50	1,43
EK KT 160-50 PG	EK KT 160-50 HDG	160	50	1,50	1,53
EK KT 200-50 PG	EK KT 200-50 HDG	200	50	1,50	1,78
EK KT 260-50 PG	EK KT 260-50 HDG	260	50	1,50	2,32
EK KT 300-50 PG	EK KT 300-50 HDG	300	50	2,00	3,50
EK KT 400-50 PG	EK KT 400-50 HDG	400	50	2,00	4,94
EK KT 500-50 PG	EK KT 500-50 HDG	500	50	2,00	6,69
EK KT 600-50 PG	EK KT 600-50 HDG	600	50	2,00	8,76

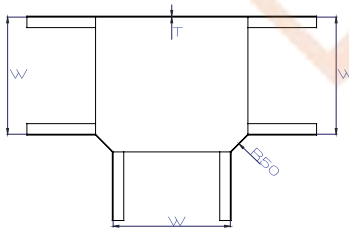

Radius 50

Used with 12 sets of CS M8 Bolt & Nuts each

H:50 Dörtlü Bağlantı Dönüş Elemanı / H:50 Horizontal Crossing

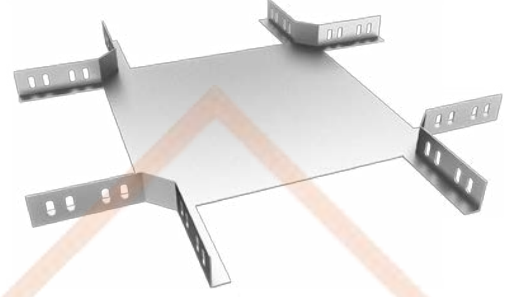
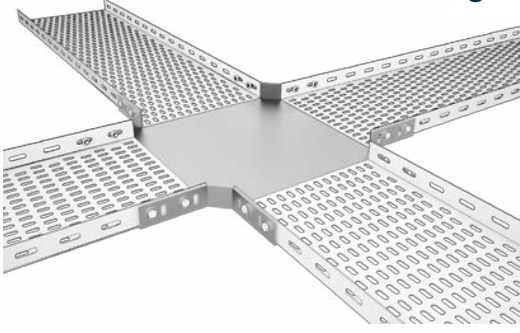

H:50 DÖRTLÜ BAĞLANTI DÖNÜŞ ELEMANLARI / H:50 HORIZONTAL CROSSINGS

Ürün Kodu / Product Code		(W) En Width	(H) Yükseklik Height	(T) Kalınlık Thickness	Ürt. Ağırlık Mnf. Weight
Pregalvaniz (PG)	Sıcak Daldırma (HDG)	(mm)	(mm)	(mm)	(kg/adet)
EK KC 50-50 PG	EK KC 50-50 HDG	50	50	1,50	1,26
EK KC 70-50 PG	EK KC 70-50 HDG	70	50	1,50	1,43
EK KC 100-50 PG	EK KC 100-50 HDG	100	50	1,50	1,45
EK KC 120-50 PG	EK KC 120-50 HDG	120	50	1,50	1,69
EK KC 160-50 PG	EK KC 160-50 HDG	160	50	1,50	1,73
EK KC 200-50 PG	EK KC 200-50 HDG	200	50	1,50	2,04
EK KC 260-50 PG	EK KC 260-50 HDG	260	50	1,50	2,42
EK KC 300-50 PG	EK KC 300-50 HDG	300	50	2,00	3,80
EK KC 400-50 PG	EK KC 400-50 HDG	400	50	2,00	5,21
EK KC 500-50 PG	EK KC 500-50 HDG	500	50	2,00	6,94
EK KC 600-50 PG	EK KC 600-50 HDG	600	50	2,00	8,97

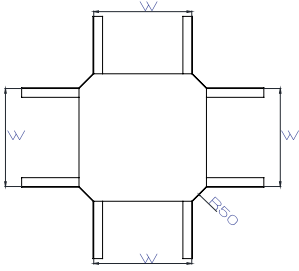

Radius 50

Used with 16 sets of CS M8 Bolt & Nuts each

H:50 45 Derece Dönüş Elemanı / H:50 Horizontal 45 Degree Bend



H:50 45 DERECE DÖNÜŞ ELEMANLARI / H:50 HORIZONTAL 45 DEGREE BENDS

Ürün Kodu / Product Code		(W) En Width	(H) Yükseklik Height	(T) Kalınlık Thickness	Ürt. Ağırlık Mnf. Weight
Pregalvaniz (PG)	Sıcak Daldırma (HDG)	(mm)	(mm)	(mm)	(kg/adet)
EK K45 50-50 PG	EK K45 50-50 HDG	50	50	1,50	1,03
EK K45 70-50 PG	EK K45 70-50 HDG	70	50	1,50	1,21
EK K45 100-50 PG	EK K45 100-50 HDG	100	50	1,50	1,25
EK K45 120-50 PG	EK K45 120-50 HDG	120	50	1,50	1,49
EK K45 160-50 PG	EK K45 160-50 HDG	160	50	1,50	1,52
EK K45 200-50 PG	EK K45 200-50 HDG	200	50	1,50	1,81
EK K45 260-50 PG	EK K45 260-50 HDG	260	50	1,50	2,16
EK K45 300-50 PG	EK K45 300-50 HDG	300	50	2,00	3,23
EK K45 400-50 PG	EK K45 400-50 HDG	400	50	2,00	4,61
EK K45 500-50 PG	EK K45 500-50 HDG	500	50	2,00	6,03
EK K45 600-50 PG	EK K45 600-50 HDG	600	50	2,00	7,67

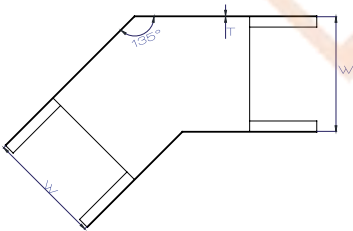

Used with 8 sets of CS M8 Bolt & Nuts each

H:50 Dış Bükey Dönüş Elemanı / H:50 Vertical Outside Bend

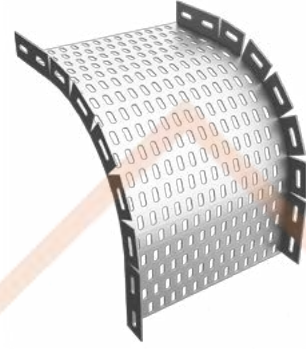

H:50 DIŞ BÜKEY DÖNÜŞ ELEMANLARI / H:50 VERTICAL OUTSIDE BENDS

Ürün Kodu / Product Code		(W) En Width	(H) Yükseklik Height	(T) Kalınlık Thickness	Ürt. Ağırlık Mnf. Weight
Pregalvaniz (PG)	Sıcak Daldırma (HDG)	(mm)	(mm)	(mm)	(kg/adet)
EK KDB 50-50 PG	EK KDB 50-50 HDG	50	50	1,00	0,80
EK KDB 70-50 PG	EK KDB 70-50 HDG	70	50	1,00	0,91
EK KDB 100-50 PG	EK KDB 100-50 HDG	100	50	1,20	1,28
EK KDB 120-50 PG	EK KDB 120-50 HDG	120	50	1,20	1,40
EK KDB 160-50 PG	EK KDB 160-50 HDG	160	50	1,20	1,65
EK KDB 200-50 PG	EK KDB 200-50 HDG	200	50	1,50	2,35
EK KDB 260-50 PG	EK KDB 260-50 HDG	260	50	1,50	2,82
EK KDB 300-50 PG	EK KDB 300-50 HDG	300	50	2,00	4,18
EK KDB 400-50 PG	EK KDB 400-50 HDG	400	50	2,00	6,53
EK KDB 500-50 PG	EK KDB 500-50 HDG	500	50	2,00	7,82
EK KDB 600-50 PG	EK KDB 600-50 HDG	600	50	2,00	9,12

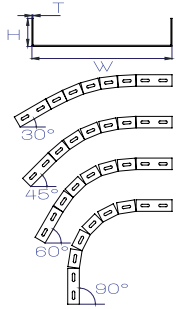

Used with 4 connectors & 8 sets of CS M8 Bolt & Nuts each

Vertical Bend delivered in plain position & may be used for 30-90 degree bendings

H:50 İç Bükey Dönüş Elemanı / H:50 Vertical Inside Bend

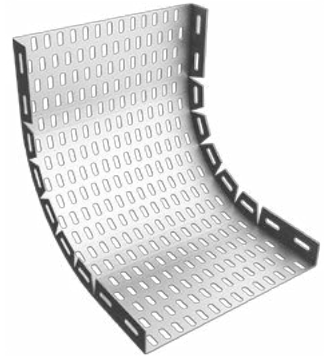
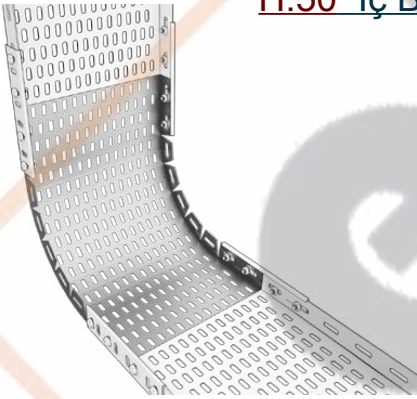

H:50 İÇ BÜKEY DÖNÜŞ ELEMANLARI / H:50 VERTICAL INSIDE BENDS

Ürün Kodu / Product Code		(W) En Width	(H) Yükseklik Height	(T) Kalınlık Thickness	Ürt. Ağırlık Mnf. Weight
Pregalvaniz (PG)	Sıcak Daldırma (HDG)	(mm)	(mm)	(mm)	(kg/adet)
EK KIB 50-50 PG	EK KIB 50-50 HDG	50	50	1,00	0,80
EK KIB 70-50 PG	EK KIB 70-50 HDG	70	50	1,00	0,91
EK KIB 100-50 PG	EK KIB 100-50 HDG	100	50	1,20	1,28
EK KIB 120-50 PG	EK KIB 120-50 HDG	120	50	1,20	1,40
EK KIB 160-50 PG	EK KIB 160-50 HDG	160	50	1,20	1,65
EK KIB 200-50 PG	EK KIB 200-50 HDG	200	50	1,50	2,35
EK KIB 260-50 PG	EK KIB 260-50 HDG	260	50	1,50	2,82
EK KIB 300-50 PG	EK KIB 300-50 HDG	300	50	2,00	4,18
EK KIB 400-50 PG	EK KIB 400-50 HDG	400	50	2,00	6,53
EK KIB 500-50 PG	EK KIB 500-50 HDG	500	50	2,00	7,82
EK KIB 600-50 PG	EK KIB 600-50 HDG	600	50	2,00	9,12

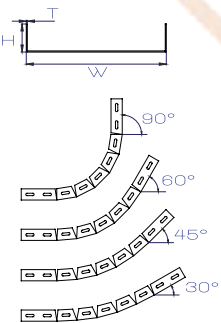

Used with 4 connectors & 8 sets of CS M8 Bolt & Nuts each

Vertical Bend delivered in plain position & may be used for 30-90 degree bendings

H:50 Redüksiyon Elemanı ( Orta ) / H:50 Middle Reducer Connector Set

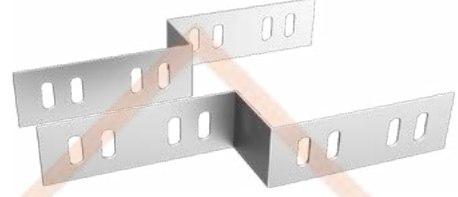
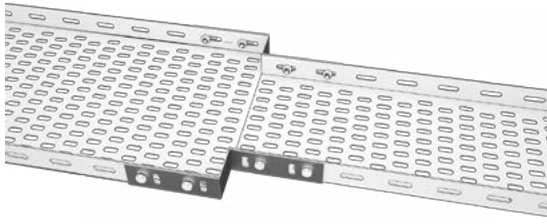

H:50 REDÜKSİYON ELEMANLARI ( ORTA ) / H:50 MIDDLE REDUCER CONNECTOR SET

Ürün Kodu / Product Code		(A) Ara Reduction	(H) Yükseklik Height	(T) Kalınlık Thickness	Ürt. Ağırlık Mnf. Weight
Pregalvaniz (PG)	Sıcak Daldırma (HDG)	(mm)	(mm)	(mm)	(kg/adet)
EK RO 40-50 PG	EK RO 40-50 HDG	40	50	1,50	0,32
EK RO 50-50 PG	EK RO 50-50 HDG	50	50	1,50	0,33
EK RO 60-50 PG	EK RO 60-50 HDG	60	50	1,50	0,34
EK RO 80-50 PG	EK RO 80-50 HDG	80	50	1,50	0,35
EK RO 100-50 PG	EK RO 100-50 HDG	100	50	1,50	0,37
EK RO 160-50 PG	EK RO 160-50 HDG	160	50	1,50	0,42
EK RO 200-50 PG	EK RO 200-50 HDG	200	50	1,50	0,43
EK RO 300-50 PG	EK RO 300-50 HDG	300	50	1,50	0,48
EK RO 400-50 PG	EK RO 400-50 HDG	400	50	1,50	0,54
EK RO 500-50 PG	EK RO 500-50 HDG	500	50	1,50	0,60

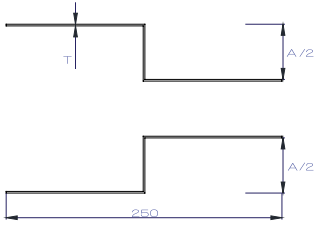

Used with 8 sets of CS M8 Bolt & Nuts each

H:50 Redüksiyon Elemanı ( Sol ) / H:50 Left Reducer Connector Set

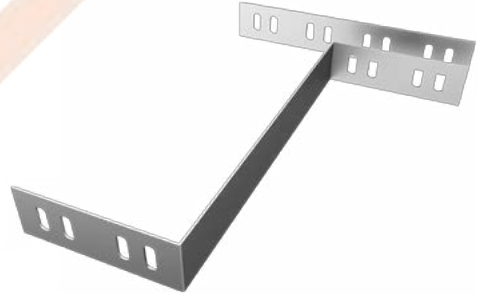
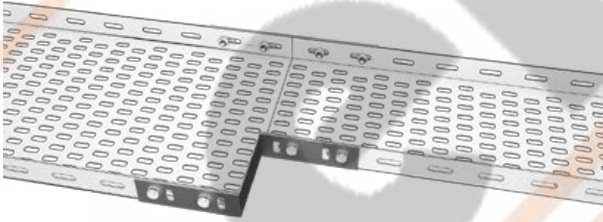

H:50 REDÜKSİYON ELEMANLARI ( SOL ) / H:50 LEFT REDUCER CONNECTOR SET

Ürün Kodu / Product Code		(A) Ara Reduction	(H) Yükseklik Height	(T) Kalınlık Thickness	Ürt. Ağırlık Mnf. Weight
Pregalvaniz (PG)	Sıcak Daldırma (HDG)	(mm)	(mm)	(mm)	(kg/adet)
EK RL 40-50 PG	EK RL 40-50 HDG	40	50	1,50	0,32
EK RL 50-50 PG	EK RL 50-50 HDG	50	50	1,50	0,33
EK RL 60-50 PG	EK RL 60-50 HDG	60	50	1,50	0,34
EK RL 80-50 PG	EK RL 80-50 HDG	80	50	1,50	0,35
EK RL 100-50 PG	EK RL 100-50 HDG	100	50	1,50	0,37
EK RL 160-50 PG	EK RL 160-50 HDG	160	50	1,50	0,42
EK RL 200-50 PG	EK RL 200-50 HDG	200	50	1,50	0,43
EK RL 300-50 PG	EK RL 300-50 HDG	300	50	1,50	0,48
EK RL 400-50 PG	EK RL 400-50 HDG	400	50	1,50	0,54
EK RL 500-50 PG	EK RL 500-50 HDG	500	50	1,50	0,60

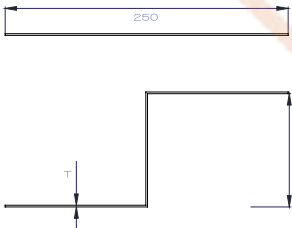

Used with 8 sets of CS M8 Bolt & Nuts each

H:50 Redüksiyon Elemanı ( Sağ ) / H:50 Right Reducer Connector Set

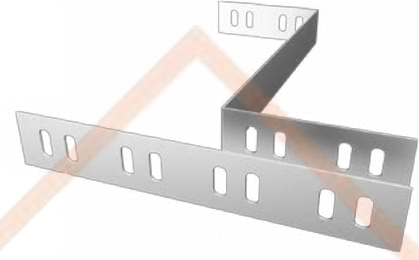
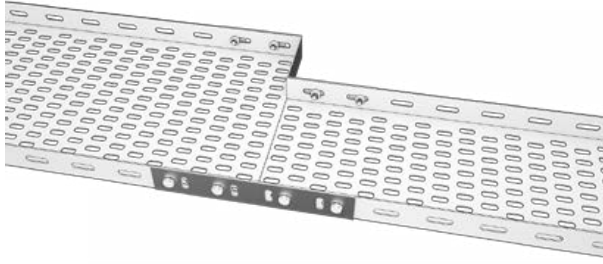

H:50 REDÜKSİYON ELEMANLARI ( SAĞ ) / H:50 RIGHT REDUCER CONNECTOR SET

Ürün Kodu / Product Code		(A) Ara Reduction	(H) Yükseklik Height	(T) Kalınlık Thickness	Ürt. Ağırlık Mnf. Weight
Pregalvaniz (PG)	Sıcak Daldırma (HDG)	(mm)	(mm)	(mm)	(kg/adet)
EK RR 40-50 PG	EK RR 40-50 HDG	40	50	1,50	0,32
EK RR 50-50 PG	EK RR 50-50 HDG	50	50	1,50	0,33
EK RR 60-50 PG	EK RR 60-50 HDG	60	50	1,50	0,34
EK RR 80-50 PG	EK RR 80-50 HDG	80	50	1,50	0,35
EK RR 100-50 PG	EK RR 100-50 HDG	100	50	1,50	0,37
EK RR 160-50 PG	EK RR 160-50 HDG	160	50	1,50	0,42
EK RR 200-50 PG	EK RR 200-50 HDG	200	50	1,50	0,43
EK RR 300-50 PG	EK RR 300-50 HDG	300	50	1,50	0,48
EK RR 400-50 PG	EK RR 400-50 HDG	400	50	2,00	0,54
EK RR 500-50 PG	EK RR 500-50 HDG	500	50	2,00	0,60

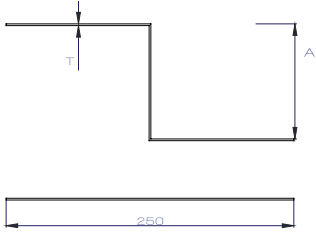

Used with 8 sets of CS M8 Bolt & Nuts each

H:50 Separatör / H:50 Separator

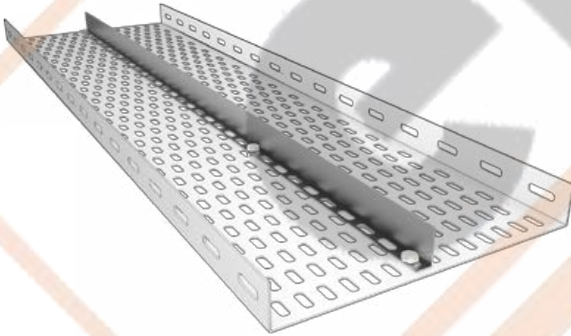

H:50 SEPERATÖR / H:50 SEPARATOR

Ürün Kodu / Product Code		(H) Yükseklik Height	(T) Kalınlık Thickness	Ürt. Ağırlık Mnf. Weight
Pregalvaniz (PG)	Sıcak Daldırma (HDG)	(mm)	(mm)	(kg/adet)
EK SEP 50-10 PG	EK SEP 50-10 HDG	50	1,00	0,51
EK SEP 50-12 PG	EK SEP 50-12 HDG	50	1,20	0,62
EK SEP 50-15 PG	EK SEP 50-15 HDG	50	1,50	0,77

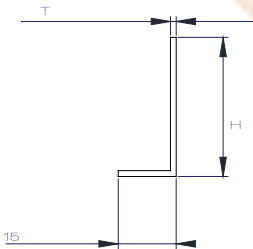

Used with CS M8 Bolt & Nuts

H:50 Sonlandırma / H:50 Stopend

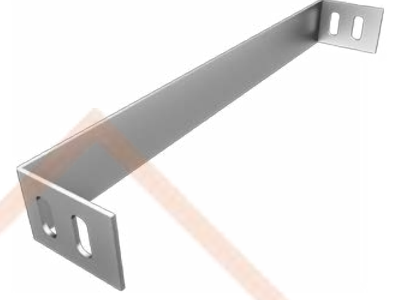
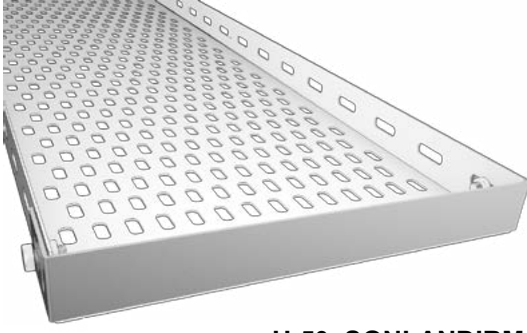

H:50 SONLANDIRMA / H:50 STOPENDS

Ürün Kodu / Product Code		(W) En Width	(H) Yükseklik Height	(T) Kalınlık Thickness	Ürt. Ağırlık Mnf. Weight
Pregalvaniz (PG)	Sıcak Daldırma (HDG)	(mm)	(mm)	(mm)	(kg/adet)
EK SON 50-50 PG	EK SON 50-50 HDG	50	50	1,50	0,18
EK SON 70-50 PG	EK SON 70-50 HDG	70	50	1,50	0,19
EK SON 100-50 PG	EK SON 100-50 HDG	100	50	1,50	0,21
EK SON 120-50 PG	EK SON 120-50 HDG	120	50	1,50	0,23
EK SON 160-50 PG	EK SON 160-50 HDG	160	50	1,50	0,25
EK SON 200-50 PG	EK SON 200-50 HDG	200	50	1,50	0,27
EK SON 260-50 PG	EK SON 260-50 HDG	260	50	1,50	0,30
EK SON 300-50 PG	EK SON 300-50 HDG	300	50	2,00	0,44
EK SON 400-50 PG	EK SON 400-50 HDG	400	50	2,00	0,51
EK SON 500-50 PG	EK SON 500-50 HDG	500	50	2,00	0,59
EK SON 600-50 PG	EK SON 600-50 HDG	600	50	2,00	0,67

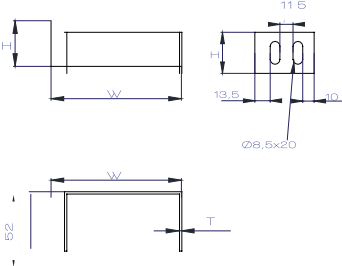

Used with 2 sets of CS M8 Bolt & Nuts

H:50 Dikey Seviye Değişirme / H:50 Vertical Adjustable Connector

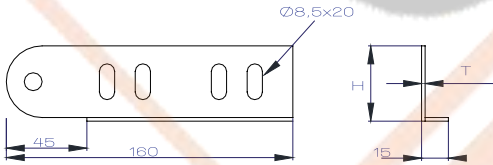
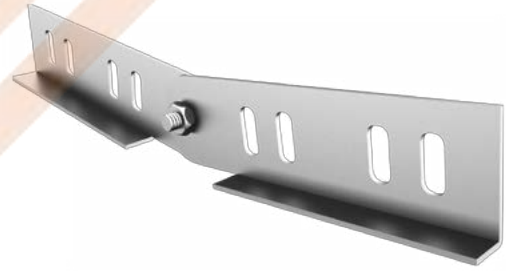
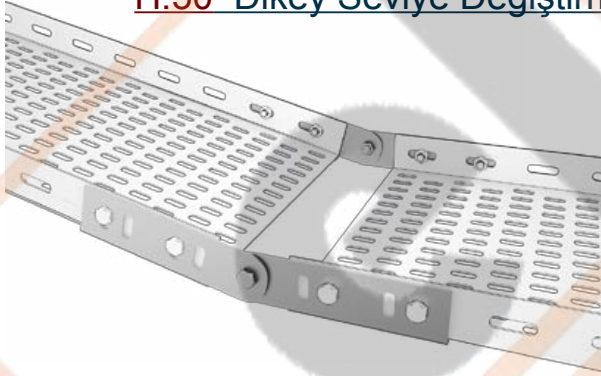

H:50 DİKEY SEVİYE DEĞİŞTİRME / H:50 VERTICAL ADJUSTABLE CONNECTOR

Ürün Kodu		(H) Yükseklik Height	(T) Kalınlık Thickness	Ürt. Ağırlık Mnf. Weight
Pregalvaniz (PG)	Sıcak Daldırma (HDG)	(mm)	(mm)	(kg/adet)
EK SVA 50-12 PG	EK SVA 50-12 HDG	50	1,20	0,22
EK SVA 50-15 PG	EK SVA 50-15 HDG	50	1,50	0,27
EK SVA 50-20 PG	EK SVA 50-20 HDG	50	2,00	0,36

Used with 8 sets of CS M8 Bolt & Nuts each

H:60 KABLO KANALLARI  
H:60 CABLE TRAYS



# H:60 STANDART DELİKLİ KABLO KANALLARI

## H:60 STANDARD PERFORATED CABLE TRAYS

**el-ka**

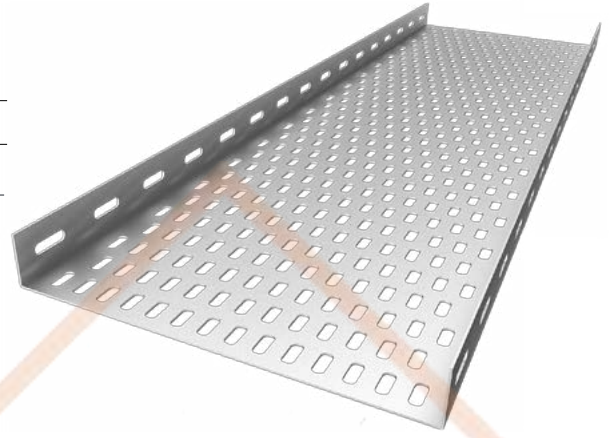
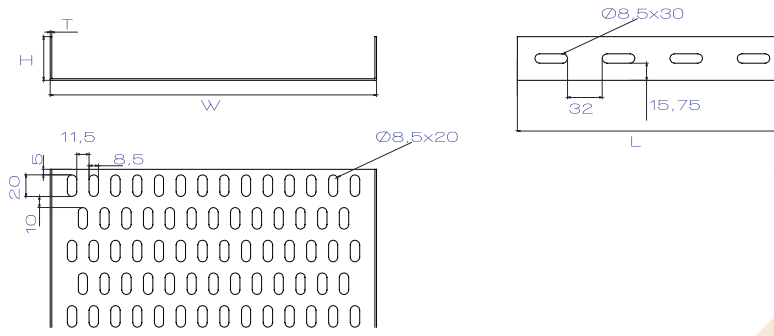

### H:60 STANDART DELİKLİ KABLO KANALLARI / H:60 STANDARD PERFORATED CABLE TRAYS

Ürün Kodu / Product Code		(W) En Width (mm)	(H) Yükseklik Height (mm)	(T) Kalınlık Thickness (mm)	Ürt. Ağırlık Mnf. Weight (kg/mt)	(L) Boy Length (mm)
Pregalvaniz (PG)	Sıcak Daldırma (HDG)					
EK SPK 70-60-08 PG	-	70	60	0,80	1,19	2500
EK SPK 70-60-10 PG	EK SPK 70-60-10 HDG	70	60	1,00	1,49	2500
EK SPK 70-60-12 PG	EK SPK 70-60-12 HDG	70	60	1,20	1,79	2500
EK SPK 70-60-15 PG	EK SPK 70-60-15 HDG	70	60	1,50	2,24	2500
EK SPK 100-60-08 PG	-	100	60	0,80	1,38	2500
EK SPK 100-60-10 PG	EK SPK 100-60-10 HDG	100	60	1,00	1,73	2500
EK SPK 100-60-12 PG	EK SPK 100-60-12 HDG	100	60	1,20	2,07	2500
EK SPK 100-60-15 PG	EK SPK 100-60-15 HDG	100	60	1,50	2,59	2500
EK SPK 120-60-10 PG	EK SPK 120-60-10 HDG	120	60	1,00	1,88	2500
EK SPK 120-60-12 PG	EK SPK 120-60-12 HDG	120	60	1,20	2,26	2500
EK SPK 120-60-15 PG	EK SPK 120-60-15 HDG	120	60	1,50	2,83	2500
EK SPK 160-60-10 PG	EK SPK 160-60-10 HDG	160	60	1,00	2,20	2500
EK SPK 160-60-12 PG	EK SPK 160-60-12 HDG	160	60	1,20	2,64	2500
EK SPK 160-60-15 PG	EK SPK 160-60-15 HDG	160	60	1,50	3,30	2500
EK SPK 200-60-10 PG	-	200	60	1,00	2,51	2500
EK SPK 200-60-12 PG	-	200	60	1,20	3,01	2500
EK SPK 200-60-15 PG	EK SPK 200-60-15 HDG	200	60	1,50	3,77	2500
EK SPK 200-60-20 PG	EK SPK 200-60-20 HDG	200	60	2,00	5,02	2500
EK SPK 260-60-12 PG	EK SPK 260-60-12 HDG	260	60	1,20	3,58	2500
EK SPK 260-60-15 PG	EK SPK 260-60-15 HDG	260	60	1,50	4,47	2500
EK SPK 260-60-20 PG	EK SPK 260-60-20 HDG	260	60	2,00	5,97	2500
EK SPK 300-60-12 PG	-	300	60	1,20	3,96	2500
EK SPK 300-60-15 PG	EK SPK 300-60-15 HDG	300	60	1,50	4,95	2500
EK SPK 300-60-20 PG	EK SPK 300-60-20 HDG	300	60	2,00	6,59	2500
EK SPK 400-60-12 PG	-	400	60	1,20	4,90	2500
EK SPK 400-60-15 PG	EK SPK 400-60-15 HDG	400	60	1,50	6,12	2500
EK SPK 400-60-20 PG	EK SPK 400-60-20 HDG	400	60	2,00	8,16	2500
EK SPK 500-60-15 PG	EK SPK 500-60-15 HDG	500	60	1,50	7,30	2500
EK SPK 500-60-20 PG	EK SPK 500-60-20 HDG	500	60	2,00	9,73	2500
EK SPK 600-60-15 PG	EK SPK 600-60-15 HDG	600	60	1,50	8,48	2500
EK SPK 600-60-20 PG	EK SPK 600-60-20 HDG	600	60	2,00	11,30	2500

H:60 Standard Cable Tray Load Graph

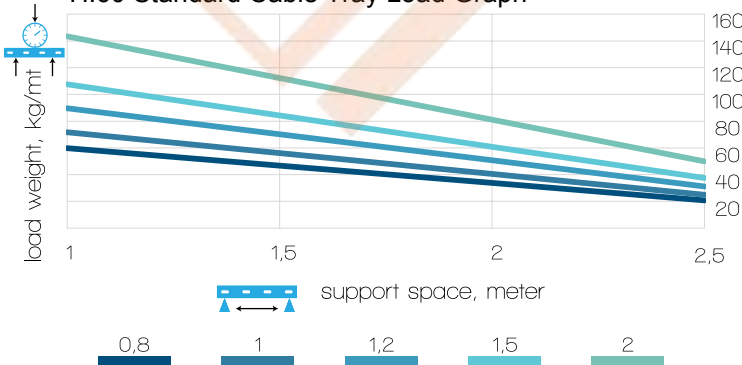

Permissible loads for a maximum deflection of 1/100th of the span, with coupling positioned at 1/5th of the span from support. The coefficient applied to the load for coupling in the middle of the span: 0.7

Safety co-efficient: 1.7

Recommended support distance: 1.5mt

Güvenlik katsayısı: 1,7

Tavsiye edilen destek konsol aralığı: 1,5mt

# H:60 STANDART DELİKSİZ KABLO KANALLARI

## H:60 STANDARD NON-PERFORATED CABLE TRAYS

**el-ka**

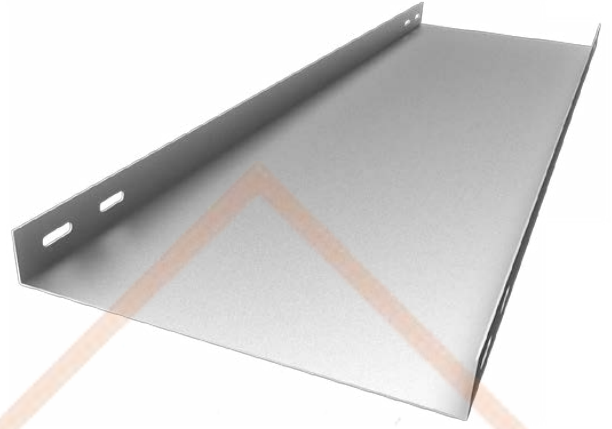
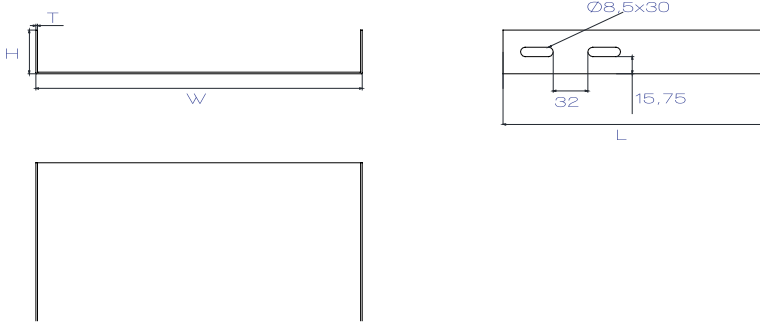

### H:60 STANDART DELİKSİZ KABLO KANALLARI / H:60 STANDARD NON-PERFORATED CABLE TRAYS

Ürün Kodu / Product Code		(W) En Width (mm)	(H) Yükseklik Height (mm)	(T) Kalınlık Thickness (mm)	Ürt. Ağırlık Mnf. Weight (kg/mt)	(L) Boy Length (mm)
Pregalvaniz (PG)	Sıcak Daldırma (HDG)					
EK SDK 70-60-08 PG	-	70	60	0,80	1,19	2500
EK SDK 70-60-10 PG	EK SDK 70-60-10 HDG	70	60	1,00	1,49	2500
EK SDK 70-60-12 PG	EK SDK 70-60-12 HDG	70	60	1,20	1,79	2500
EK SDK 70-60-15 PG	EK SDK 70-60-15 HDG	70	60	1,50	2,24	2500
EK SDK 100-60-08 PG	-	100	60	0,80	1,38	2500
EK SDK 100-60-10 PG	EK SDK 100-60-10 HDG	100	60	1,00	1,73	2500
EK SDK 100-60-12 PG	EK SDK 100-60-12 HDG	100	60	1,20	2,07	2500
EK SDK 100-60-15 PG	EK SDK 100-60-15 HDG	100	60	1,50	2,59	2500
EK SDK 120-60-10 PG	EK SDK 120-60-10 HDG	120	60	1,00	1,88	2500
EK SDK 120-60-12 PG	EK SDK 120-60-12 HDG	120	60	1,20	2,26	2500
EK SDK 120-60-15 PG	EK SDK 120-60-15 HDG	120	60	1,50	2,83	2500
EK SDK 160-60-10 PG	EK SDK 160-60-10 HDG	160	60	1,00	2,20	2500
EK SDK 160-60-12 PG	EK SDK 160-60-12 HDG	160	60	1,20	2,64	2500
EK SDK 160-60-15 PG	EK SDK 160-60-15 HDG	160	60	1,50	3,30	2500
EK SDK 200-60-10 PG	-	200	60	1,00	2,51	2500
EK SDK 200-60-12 PG	-	200	60	1,20	3,01	2500
EK SDK 200-60-15 PG	EK SDK 200-60-15 HDG	200	60	1,50	3,77	2500
EK SDK 200-60-20 PG	EK SDK 200-60-20 HDG	200	60	2,00	5,02	2500
EK SDK 260-60-12 PG	EK SDK 260-60-12 HDG	260	60	1,20	3,58	2500
EK SDK 260-60-15 PG	EK SDK 260-60-15 HDG	260	60	1,50	4,47	2500
EK SDK 260-60-20 PG	EK SDK 260-60-20 HDG	260	60	2,00	5,97	2500
EK SDK 300-60-12 PG	-	300	60	1,20	3,96	2500
EK SDK 300-60-15 PG	EK SDK 300-60-15 HDG	300	60	1,50	4,95	2500
EK SDK 300-60-20 PG	EK SDK 300-60-20 HDG	300	60	2,00	6,59	2500
EK SDK 400-60-12 PG	-	400	60	1,20	4,90	2500
EK SDK 400-60-15 PG	EK SDK 400-60-15 HDG	400	60	1,50	6,12	2500
EK SDK 400-60-20 PG	EK SDK 400-60-20 HDG	400	60	2,00	8,16	2500
EK SDK 500-60-15 PG	EK SDK 500-60-15 HDG	500	60	1,50	7,30	2500
EK SDK 500-60-20 PG	EK SDK 500-60-20 HDG	500	60	2,00	9,73	2500
EK SDK 600-60-15 PG	EK SDK 600-60-15 HDG	600	60	1,50	8,48	2500
EK SDK 600-60-20 PG	EK SDK 600-60-20 HDG	600	60	2,00	11,30	2500

H:60 Standard Cable Tray Load Graph

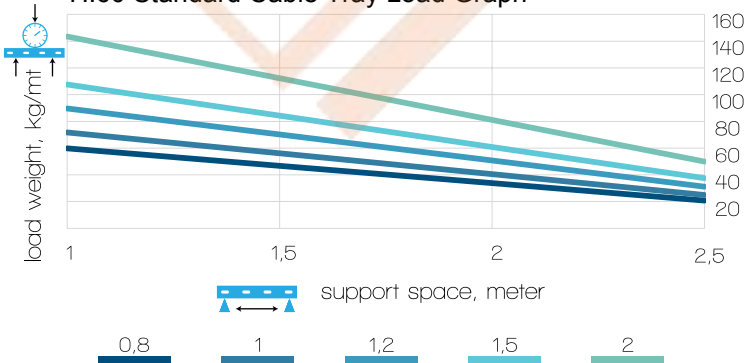

Permissible loads for a maximum deflection of 1/100th of the span, with coupling positioned at 1/5th of the span from support. The coefficient applied to the load for coupling in the middle of the span: 0.7

Safety co-efficient: 1.7

Recommended support distance: 1.5mt

Güvenlik katsayısı: 1,7

Tavsiye edilen destek konsol aralığı: 1,5mt

# H:60 AĞIR HİZMET DELİKLİ KABLO KANALLARI

## H:60 HEAVY DUTY PERFORATED CABLE TRAYS

**el-ka**

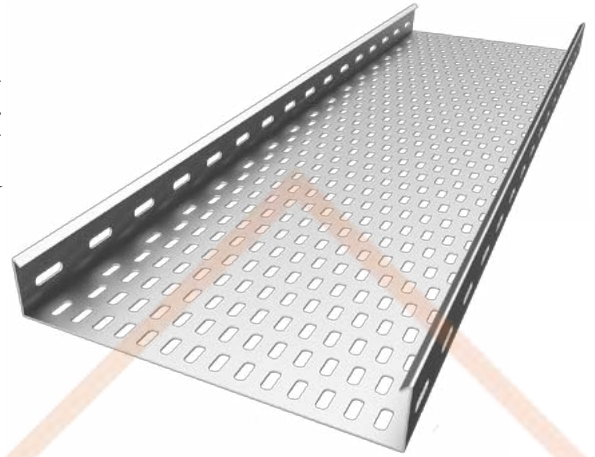
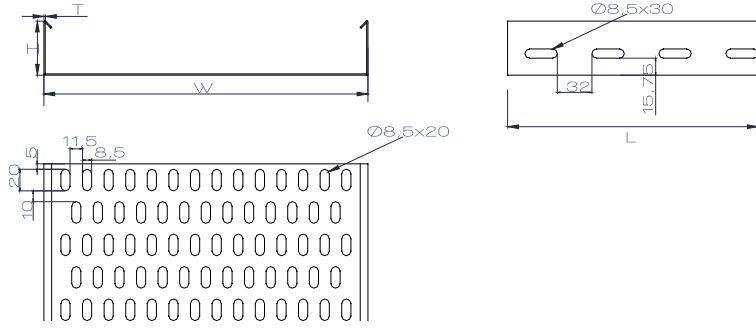

### H:60 AĞIR HİZMET DELİKLİ KABLO KANALLARI / H:60 HEAVY DUTY PERFORATED CABLE TRAYS

Ürün Kodu / Product Code		(W) En Width (mm)	(H) Yükseklik Height (mm)	(T) Kalınlık Thickness (mm)	Ürt. Ağırlık Mnf. Weight (kg/mt)	(L) Boy Length (mm)
Pregalvaniz (PG)	Sıcak Daldırma (HDG)					
EK APK 70-60-08 PG	-	70	60	0,80	1,32	2500
EK APK 70-60-10 PG	EK APK 70-60-10 HDG	70	60	1,00	1,65	2500
EK APK 70-60-12 PG	EK APK 70-60-12 HDG	70	60	1,20	1,98	2500
EK APK 70-60-15 PG	EK APK 70-60-15 HDG	70	60	1,50	2,47	2500
EK APK 100-60-08 PG	-	100	60	0,80	1,51	2500
EK APK 100-60-10 PG	EK APK 100-60-10 HDG	100	60	1,00	1,88	2500
EK APK 100-60-12 PG	EK APK 100-60-12 HDG	100	60	1,20	2,26	2500
EK APK 100-60-15 PG	EK APK 100-60-15 HDG	100	60	1,50	2,83	2500
EK APK 120-60-10 PG	EK APK 120-60-10 HDG	120	60	1,00	2,04	2500
EK APK 120-60-12 PG	EK APK 120-60-12 HDG	120	60	1,20	2,45	2500
EK APK 120-60-15 PG	EK APK 120-60-15 HDG	120	60	1,50	3,06	2500
EK APK 160-60-10 PG	EK APK 160-60-10 HDG	160	60	1,00	2,36	2500
EK APK 160-60-12 PG	EK APK 160-60-12 HDG	160	60	1,20	2,83	2500
EK APK 160-60-15 PG	EK APK 160-60-15 HDG	160	60	1,50	3,53	2500
EK APK 200-60-10 PG	-	200	60	1,00	2,67	2500
EK APK 200-60-12 PG	-	200	60	1,20	3,20	2500
EK APK 200-60-15 PG	EK APK 200-60-15 HDG	200	60	1,50	4,00	2500
EK APK 200-60-20 PG	EK APK 200-60-20 HDG	200	60	2,00	5,34	2500
EK APK 260-60-12 PG	EK APK 260-60-12 HDG	260	60	1,20	3,77	2500
EK APK 260-60-15 PG	EK APK 260-60-15 HDG	260	60	1,50	4,71	2500
EK APK 260-60-20 PG	EK APK 260-60-20 HDG	260	60	2,00	6,28	2500
EK APK 300-60-12 PG	-	300	60	1,20	4,14	2500
EK APK 300-60-15 PG	EK APK 300-60-15 HDG	300	60	1,50	5,18	2500
EK APK 300-60-20 PG	EK APK 300-60-20 HDG	300	60	2,00	6,91	2500
EK APK 400-60-12 PG	-	400	60	1,20	5,09	2500
EK APK 400-60-15 PG	EK APK 400-60-15 HDG	400	60	1,50	6,36	2500
EK APK 400-60-20 PG	EK APK 400-60-20 HDG	400	60	2,00	8,48	2500
EK APK 500-60-15 PG	EK APK 500-60-15 HDG	500	60	1,50	7,54	2500
EK APK 500-60-20 PG	EK APK 500-60-20 HDG	500	60	2,00	10,05	2500
EK APK 600-60-15 PG	EK APK 600-60-15 HDG	600	60	1,50	8,71	2500
EK APK 600-60-20 PG	EK APK 600-60-20 HDG	600	60	2,00	11,62	2500

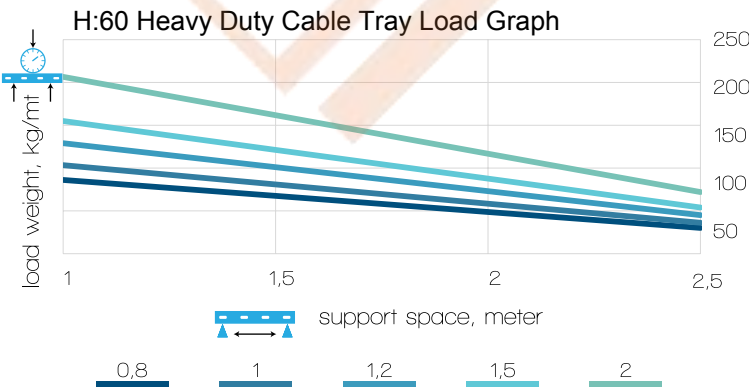

Permissible loads for a maximum deflection of 1/100th of the span, with coupling positioned at 1/5th of the span from support. The coefficient applied to the load for coupling in the middle of the span: 0.7

Safety co-efficient: 1.7

Recommended support distance: 1.5mt

Güvenlik katsayısı: 1,7

Tavsiye edilen destek konsol aralığı: 1,5mt

# H:60 AĞIR HİZMET DELİKSİZ KABLO KANALLARI

## H:60 HEAVY DUTY NON-PERFORATED CABLE TRAYS

**el-ka**

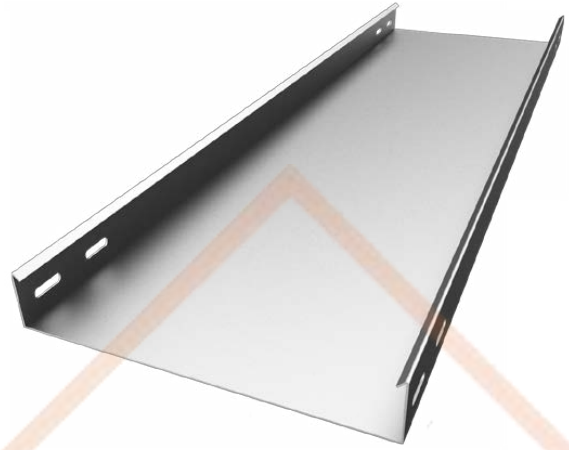
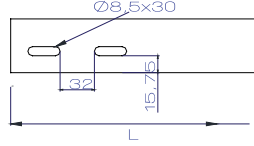
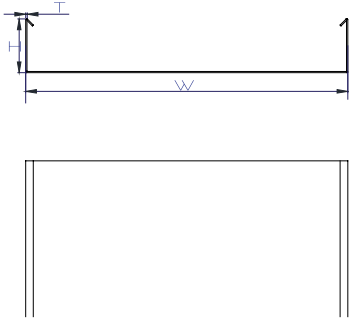

### H:60 AĞIR HİZMET DELİKSİZ KABLO KANALLARI / H:60 HEAVY DUTY NON-PERFORATED CABLE TRAYS

Ürün Kodu / Product Code		(W) En Width (mm)	(H) Yükseklik Height (mm)	(T) Kalınlık Thickness (mm)	Ürt. Ağırlık Mnf. Weight (kg/mt)	(L) Boy Length (mm)
<b>Pregalvaniz (PG)</b>	<b>Sıcak Daldırma (HDG)</b>					
EK ADK 70-60-08 PG	-	70	60	0,80	1,32	2500
EK ADK 70-60-10 PG	EK ADK 70-60-10 HDG	70	60	1,00	1,65	2500
EK ADK 70-60-12 PG	EK ADK 70-60-12 HDG	70	60	1,20	1,98	2500
EK ADK 70-60-15 PG	EK ADK 70-60-15 HDG	70	60	1,50	2,47	2500
EK ADK 100-60-08 PG	-	100	60	0,80	1,51	2500
EK ADK 100-60-10 PG	EK ADK 100-60-10 HDG	100	60	1,00	1,88	2500
EK ADK 100-60-12 PG	EK ADK 100-60-12 HDG	100	60	1,20	2,26	2500
EK ADK 100-60-15 PG	EK ADK 100-60-15 HDG	100	60	1,50	2,83	2500
EK ADK 120-60-10 PG	EK ADK 120-60-10 HDG	120	60	1,00	2,04	2500
EK ADK 120-60-12 PG	EK ADK 120-60-12 HDG	120	60	1,20	2,45	2500
EK ADK 120-60-15 PG	EK ADK 120-60-15 HDG	120	60	1,50	3,06	2500
EK ADK 160-60-10 PG	EK ADK 160-60-10 HDG	160	60	1,00	2,36	2500
EK ADK 160-60-12 PG	EK ADK 160-60-12 HDG	160	60	1,20	2,83	2500
EK ADK 160-60-15 PG	EK ADK 160-60-15 HDG	160	60	1,50	3,53	2500
EK ADK 200-60-10 PG	-	200	60	1,00	2,67	2500
EK ADK 200-60-12 PG	-	200	60	1,20	3,20	2500
EK ADK 200-60-15 PG	EK ADK 200-60-15 HDG	200	60	1,50	4,00	2500
EK ADK 200-60-20 PG	EK ADK 200-60-20 HDG	200	60	2,00	5,34	2500
EK ADK 260-60-12 PG	EK ADK 260-60-12 HDG	260	60	1,20	3,77	2500
EK ADK 260-60-15 PG	EK ADK 260-60-15 HDG	260	60	1,50	4,71	2500
EK ADK 260-60-20 PG	EK ADK 260-60-20 HDG	260	60	2,00	6,28	2500
EK ADK 300-60-12 PG	-	300	60	1,20	4,14	2500
EK ADK 300-60-15 PG	EK ADK 300-60-15 HDG	300	60	1,50	5,18	2500
EK ADK 300-60-20 PG	EK ADK 300-60-20 HDG	300	60	2,00	6,91	2500
EK ADK 400-60-12 PG	-	400	60	1,20	5,09	2500
EK ADK 400-60-15 PG	EK ADK 400-60-15 HDG	400	60	1,50	6,36	2500
EK ADK 400-60-20 PG	EK ADK 400-60-20 HDG	400	60	2,00	8,48	2500
EK ADK 500-60-15 PG	EK ADK 500-60-15 HDG	500	60	1,50	7,54	2500
EK ADK 500-60-20 PG	EK ADK 500-60-20 HDG	500	60	2,00	10,05	2500
EK ADK 600-60-15 PG	EK ADK 600-60-15 HDG	600	60	1,50	8,71	2500
EK ADK 600-60-20 PG	EK ADK 600-60-20 HDG	600	60	2,00	11,62	2500

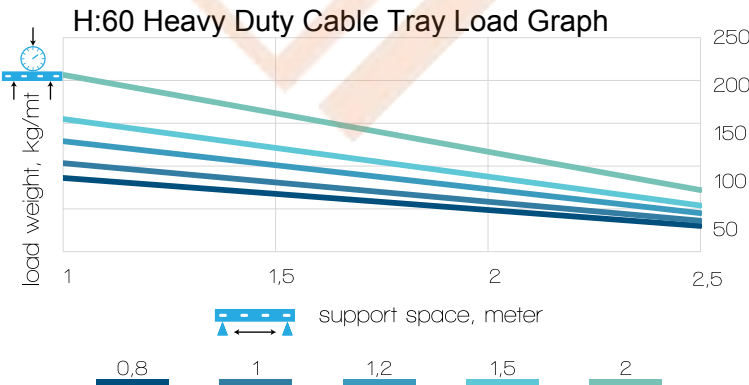

Permissible loads for a maximum deflection of 1/100th of the span, with coupling positioned at 1/5th of the span from support. The coefficient applied to the load for coupling in the middle of the span: 0.7

Safety co-efficient: 1.7

Recommended support distance: 1.5mt

Güvenlik katsayısı: 1,7

Tavsiye edilen destek konsol aralığı: 1,5mt

H:60 Birleştirme Ek Elemanı / H:60 Straight Coupler

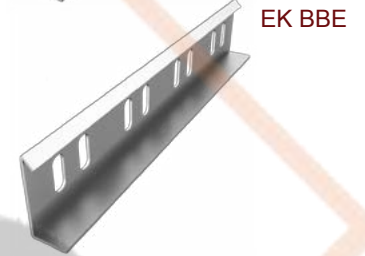
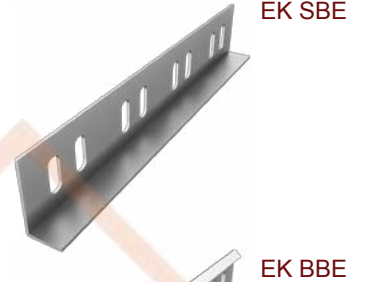
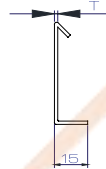
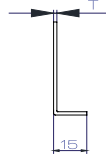
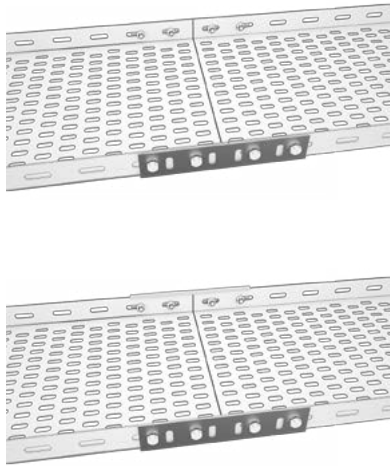

H:60 BİRLEŞTİRME EK ELEMANI / H:60 STRAIGHT CONNECTOR

Ürün Kodu / Product Code		(H) Yükseklik Height (mm)	(T) Kalınlık Thickness (mm)	Ürt. Ağırlık Mnf. Weight (kg/adet)
Pregalvaniz (PG)	Sıcak Daldırma (HDG)			
EK SBE 60-12 PG	EK SBE 60-12 HDG	60	1,20	0,18
EK SBE 60-15 PG	EK SBE 60-15 HDG	60	1,50	0,22
EK BBE 60-12 PG	EK BBE 60-12 HDG	60	1,20	0,20
EK BBE 60-15 PG	EK BBE 60-15 HDG	60	1,50	0,25

M8 CİVATA VE SOMUN / M8 BOLT & NUT



Ürün Kodu / Product Code		Ebat Size (mm)	Ağırlık Weight (kg/adet)
Galvaniz	Dakromet		
CS M8	CS M8 D	M8X15	0,012

Used with 4 sets of CS M8 Bolt & Nuts each

H:60 Yatay Seviye Değişirme / H:60 Horizontal Adjustable Connector

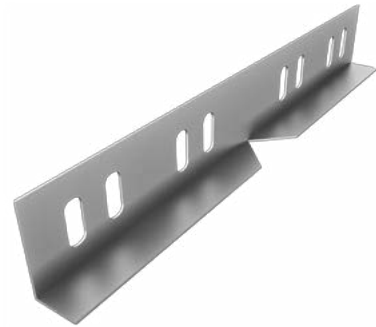
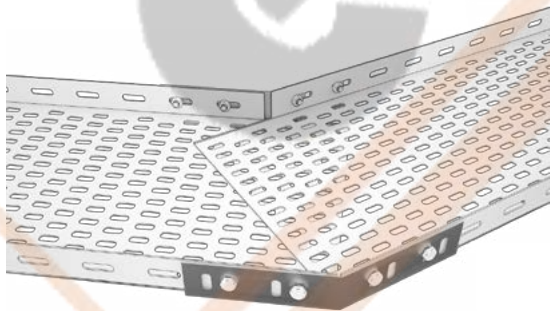

H:60 YATAY SEVİYE DEĞİŞTİRME / H:60 HORIZONTAL ADJUSTABLE CONNECTOR

Ürün Kodu / Product Code		(H) Yükseklik Height (mm)	(T) Kalınlık Thickness (mm)	Ürt. Ağırlık Mnf. Weight (kg/adet)
Pregalvaniz (PG)	Sıcak Daldırma (HDG)			
EK SHA 60-12 PG	EK SHA 60-12 HDG	60	1,20	0,19
EK SHA 60-15 PG	EK SHA 60-15 HDG	60	1,50	0,24
EK SHA 60-20 PG	EK SHA 60-20 HDG	60	2,00	0,32

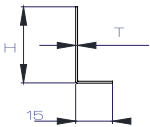

Used with 4 sets of CS M8 Bolt & Nuts each

H:60 90 Derece Dönüş Elemanı / H:60 Horizontal 90 Degree Bend

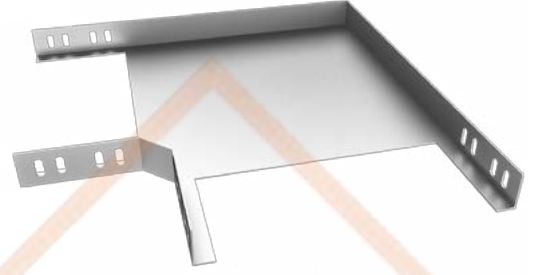

H:60 90 DERECE DÖNÜŞ ELEMANLARI / H:60 HORIZONTAL 90 DEGREE BENDS

Ürün Kodu / Product Code		(W) En Width	(H) Yükseklik Height	(T) Kalınlık Thickness	Urt. Ağırlık Mnf. Weight
Pregalvaniz (PG)	Sıcak Daldırma (HDG)	(mm)	(mm)	(mm)	(kg/adet)
EK K90 100-60 PG	EK K90 100-60 HDG	100	60	1,50	1,03
EK K90 120-60 PG	EK K90 120-60 HDG	120	60	1,50	1,31
EK K90 160-60 PG	EK K90 160-60 HDG	160	60	1,50	1,36
EK K90 200-60 PG	EK K90 200-60 HDG	200	60	1,50	1,67
EK K90 260-60 PG	EK K90 260-60 HDG	260	60	1,50	2,11
EK K90 300-60 PG	EK K90 300-60 HDG	300	60	2,00	3,43
EK K90 400-60 PG	EK K90 400-60 HDG	400	60	2,00	4,74
EK K90 500-60 PG	EK K90 500-60 HDG	500	60	2,00	6,75
EK K90 600-60 PG	EK K90 600-60 HDG	600	60	2,00	8,88

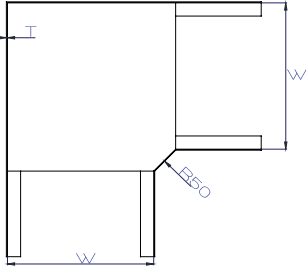

Radius 50

Used with 8 sets of CS M8 Bolt & Nuts each

H:60 T Dönüş Elemanı / H:60 Horizontal Tee Bend

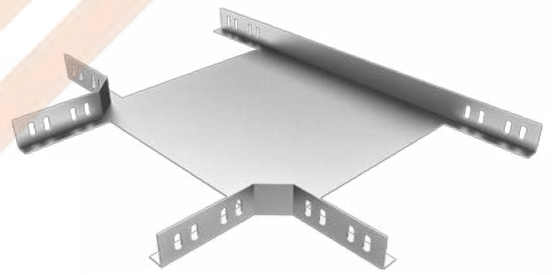
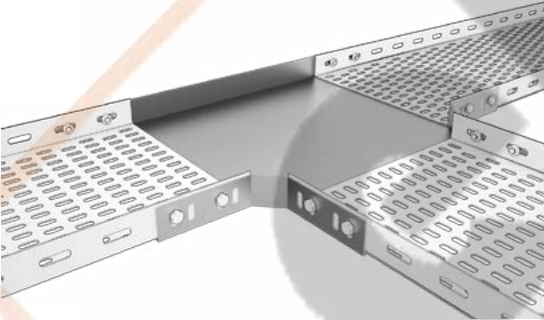

H:60 T DÖNÜŞ ELEMANLARI / H:60 HORIZONTAL TEE BENDS

Ürün Kodu / Product Code		(W) En Width	(H) Yükseklik Height	(T) Kalınlık Thickness	Urt. Ağırlık Mnf. Weight
Pregalvaniz (PG)	Sıcak Daldırma (HDG)	(mm)	(mm)	(mm)	(kg/adet)
EK KT 100-60 PG	EK KT 100-60 HDG	100	60	1,50	1,33
EK KT 120-60 PG	EK KT 120-60 HDG	120	60	1,50	1,57
EK KT 160-60 PG	EK KT 160-60 HDG	160	60	1,50	1,67
EK KT 200-60 PG	EK KT 200-60 HDG	200	60	1,50	1,93
EK KT 260-60 PG	EK KT 260-60 HDG	260	60	1,50	2,48
EK KT 300-60 PG	EK KT 300-60 HDG	300	60	2,00	3,72
EK KT 400-60 PG	EK KT 400-60 HDG	400	60	2,00	5,18
EK KT 500-60 PG	EK KT 500-60 HDG	500	60	2,00	6,95
EK KT 600-60 PG	EK KT 600-60 HDG	600	60	2,00	9,04

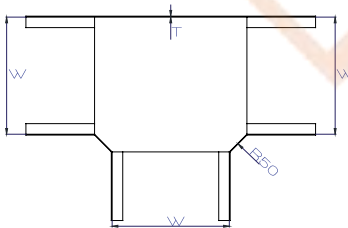

Radius 50

Used with 12 sets of CS M8 Bolt & Nuts each

H:60 Dörtlü Bağlantı Dönüş Elemanı / H:60 Horizontal Crossing

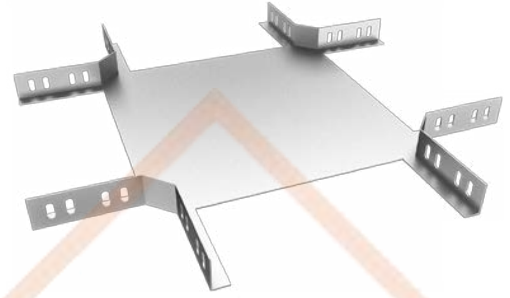
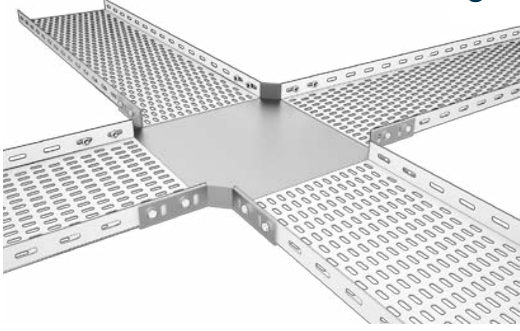

H:60 DÖRTLÜ BAĞLANTI DÖNÜŞ ELEMANLARI / H:60 HORIZONTAL CROSSINGS

Ürün Kodu / Product Code		(W) En Width (mm)	(H) Yükseklik Height (mm)	(T) Kalınlık Thickness (mm)	Urt. Ağırlık Mnf. Weight (kg/adet)
Pregalvaniz (PG)	Sıcak Daldırma (HDG)				
EK KC 100-60 PG	EK KC 100-60 HDG	100	60	1,50	1,63
EK KC 120-60 PG	EK KC 120-60 HDG	120	60	1,50	1,87
EK KC 160-60 PG	EK KC 160-60 HDG	160	60	1,50	1,91
EK KC 200-60 PG	EK KC 200-60 HDG	200	60	1,50	2,22
EK KC 260-60 PG	EK KC 260-60 HDG	260	60	1,50	2,60
EK KC 300-60 PG	EK KC 300-60 HDG	300	60	2,00	4,03
EK KC 400-60 PG	EK KC 400-60 HDG	400	60	2,00	5,44
EK KC 500-60 PG	EK KC 500-60 HDG	500	60	2,00	7,17
EK KC 600-60 PG	EK KC 600-60 HDG	600	60	2,00	9,20

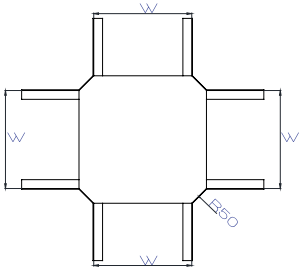

Radius 50

Used with 16 sets of CS M8 Bolt & Nuts each

H:60 45 Derece Dönüş Elemanı / H:60 Horizontal 45 Degree Bend

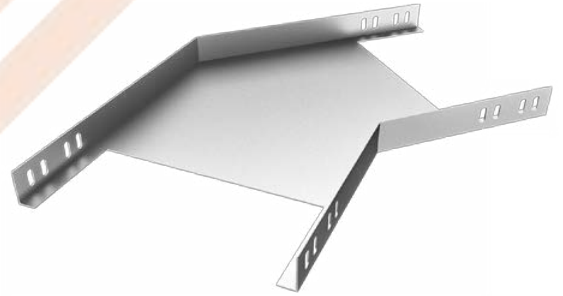

H:60 45 DERECE DÖNÜŞ ELEMANLARI / H:60 HORIZONTAL 45 DEGREE BENDS

Ürün Kodu / Product Code		(W) En Width (mm)	(H) Yükseklik Height (mm)	(T) Kalınlık Thickness (mm)	Urt. Ağırlık Mnf. Weight (kg/adet)
Pregalvaniz (PG)	Sıcak Daldırma (HDG)				
EK K45 100-60 PG	EK K45 100-60 HDG	100	60	1,50	1,39
EK K45 120-60 PG	EK K45 120-60 HDG	120	60	1,50	1,63
EK K45 160-60 PG	EK K45 160-60 HDG	160	60	1,50	1,66
EK K45 200-60 PG	EK K45 200-60 HDG	200	60	1,50	1,95
EK K45 260-60 PG	EK K45 260-60 HDG	260	60	1,50	2,30
EK K45 300-60 PG	EK K45 300-60 HDG	300	60	2,00	3,45
EK K45 400-60 PG	EK K45 400-60 HDG	400	60	2,00	4,83
EK K45 500-60 PG	EK K45 500-60 HDG	500	60	2,00	6,25
EK K45 600-60 PG	EK K45 600-60 HDG	600	60	2,00	7,89

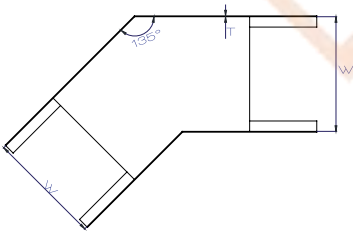

Used with 8 sets of CS M8 Bolt & Nuts each

H:60 Dış Bükey Dönüş Elemanı / H:60 Vertical Outside Bend

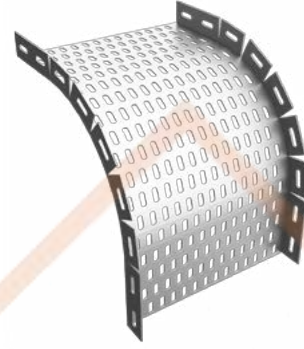

H:60 DIŞ BÜKEY DÖNÜŞ ELEMANLARI / H:60 VERTICAL OUTSIDE BENDS

Ürün Kodu / Product Code		(W) En Width	(H) Yükseklik Height	(T) Kalınlık Thickness	Ürt. Ağırlık Mnf. Weight
Pregalvaniz (PG)	Sıcak Daldırma (HDG)	(mm)	(mm)	(mm)	(kg/adet)
EK KDB 100-60 PG	EK KDB 100-60 HDG	100	60	1,20	1,44
EK KDB 120-60 PG	EK KDB 120-60 HDG	120	60	1,20	1,56
EK KDB 160-60 PG	EK KDB 160-60 HDG	160	60	1,20	1,80
EK KDB 200-60 PG	EK KDB 200-60 HDG	200	60	1,50	2,52
EK KDB 260-60 PG	EK KDB 260-60 HDG	260	60	1,50	3,00
EK KDB 300-60 PG	EK KDB 300-60 HDG	300	60	2,00	4,42
EK KDB 400-60 PG	EK KDB 400-60 HDG	400	60	2,00	6,83
EK KDB 500-60 PG	EK KDB 500-60 HDG	500	60	2,00	8,13
EK KDB 600-60 PG	EK KDB 600-60 HDG	600	60	2,00	9,43

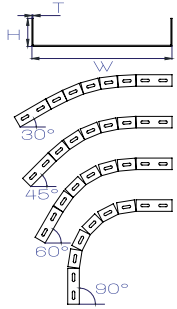

Used with 4 connectors & 8 sets of CS M8 Bolt & Nuts each

Vertical Bend delivered in plain position & may be used for 30-90 degree bendings

H:60 İç Bükey Dönüş Elemanı / H:60 Vertical Inside Bend

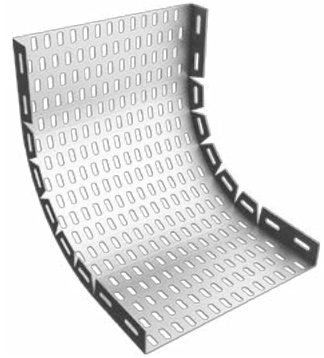
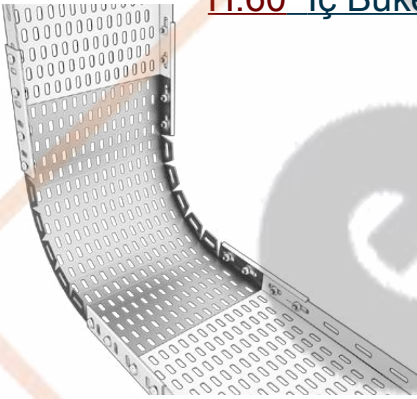

H:60 İÇ BÜKEY DÖNÜŞ ELEMANLARI / H:60 VERTICAL INSIDE BENDS

Ürün Kodu / Product Code		(W) En Width	(H) Yükseklik Height	(T) Kalınlık Thickness	Ürt. Ağırlık Mnf. Weight
Pregalvaniz (PG)	Sıcak Daldırma (HDG)	(mm)	(mm)	(mm)	(kg/adet)
EK KIB 100-60 PG	EK KIB 100-60 HDG	100	60	1,20	1,44
EK KIB 120-60 PG	EK KIB 120-60 HDG	120	60	1,20	1,56
EK KIB 160-60 PG	EK KIB 160-60 HDG	160	60	1,20	1,80
EK KIB 200-60 PG	EK KIB 200-60 HDG	200	60	1,50	2,52
EK KIB 260-60 PG	EK KIB 260-60 HDG	260	60	1,50	3,00
EK KIB 300-60 PG	EK KIB 300-60 HDG	300	60	2,00	4,42
EK KIB 400-60 PG	EK KIB 400-60 HDG	400	60	2,00	6,83
EK KIB 500-60 PG	EK KIB 500-60 HDG	500	60	2,00	8,13
EK KIB 600-60 PG	EK KIB 600-60 HDG	600	60	2,00	9,43

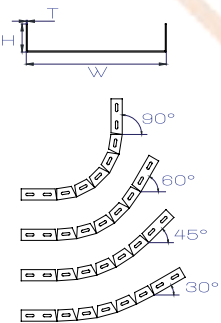

Used with 4 connectors & 8 sets of CS M8 Bolt & Nuts each

Vertical Bend delivered in plain position & may be used for 30-90 degree bendings



H:60 Redüksiyon Elemanı ( Orta ) / H:60 Middle Reducer Connector Set

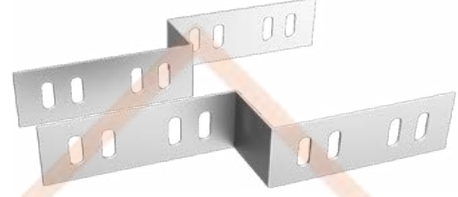
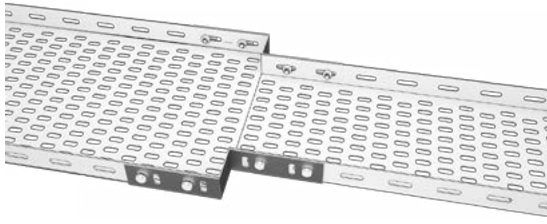

H:60 REDÜKSİYON ELEMANLARI ( ORTA ) / H:60 MIDDLE REDUCER CONNECTOR SET

Ürün Kodu / Product Code		(A) Ara Reduction	(H) Yükseklik Height	(T) Kalınlık Thickness	Ürt. Ağırlık Mnf. Weight
Pregalvaniz (PG)	Sıcak Daldırma (HDG)	(mm)	(mm)	(mm)	(kg/adet)
EK RO 40-60 PG	EK RO 40-60 HDG	40	60	1,50	0,38
EK RO 50-60 PG	EK RO 50-60 HDG	50	60	1,50	0,39
EK RO 60-60 PG	EK RO 60-60 HDG	60	60	1,50	0,40
EK RO 80-60 PG	EK RO 80-60 HDG	80	60	1,50	0,41
EK RO 100-60 PG	EK RO 100-60 HDG	100	60	1,50	0,43
EK RO 160-60 PG	EK RO 160-60 HDG	160	60	1,50	0,49
EK RO 200-60 PG	EK RO 200-60 HDG	200	60	1,50	0,51
EK RO 300-60 PG	EK RO 300-60 HDG	300	60	1,50	0,58
EK RO 400-60 PG	EK RO 400-60 HDG	400	60	1,50	0,64
EK RO 500-60 PG	EK RO 500-60 HDG	500	60	1,50	0,71

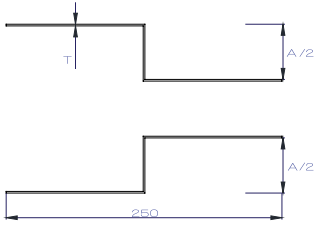

Used with 8 sets of CS M8 Bolt & Nuts each

H:60 Redüksiyon Elemanı ( Sol ) / H:60 Left Reducer Connector Set

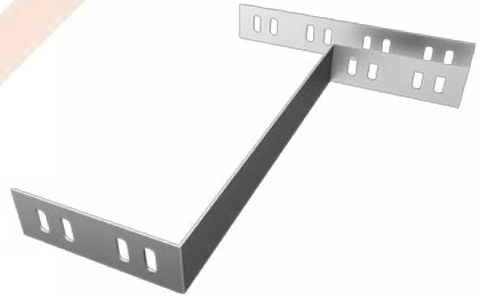
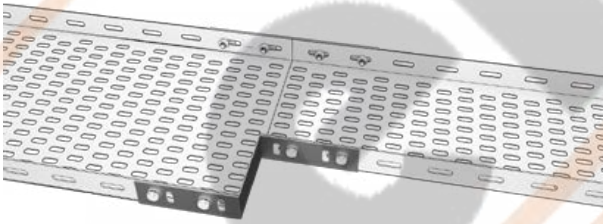

H:60 REDÜKSİYON ELEMANLARI ( SOL ) / H:60 LEFT REDUCER CONNECTOR SET

Ürün Kodu / Product Code		(A) Ara Reduction	(H) Yükseklik Height	(T) Kalınlık Thickness	Ürt. Ağırlık Mnf. Weight
Pregalvaniz (PG)	Sıcak Daldırma (HDG)	(mm)	(mm)	(mm)	(kg/adet)
EK RL 40-60 PG	EK RL 40-60 HDG	40	60	1,50	0,38
EK RL 50-60 PG	EK RL 50-60 HDG	50	60	1,50	0,39
EK RL 60-60 PG	EK RL 60-60 HDG	60	60	1,50	0,40
EK RL 80-60 PG	EK RL 80-60 HDG	80	60	1,50	0,41
EK RL 100-60 PG	EK RL 100-60 HDG	100	60	1,50	0,43
EK RL 160-60 PG	EK RL 160-60 HDG	160	60	1,50	0,49
EK RL 200-60 PG	EK RL 200-60 HDG	200	60	1,50	0,51
EK RL 300-60 PG	EK RL 300-60 HDG	300	60	1,50	0,58
EK RL 400-60 PG	EK RL 400-60 HDG	400	60	1,50	0,64
EK RL 500-60 PG	EK RL 500-60 HDG	500	60	1,50	0,71

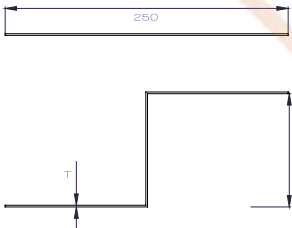

Used with 8 sets of CS M8 Bolt & Nuts each

H:60 Redüksiyon Elemanı ( Sağ ) / H:60 Right Reducer Connector Set

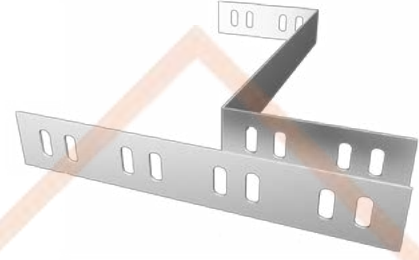
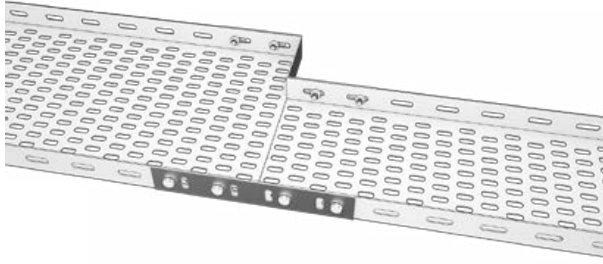

H:60 REDÜKSİYON ELEMANLARI ( SAĞ ) / H:60 RIGHT REDUCER CONNECTOR SET

Ürün Kodu / Product Code		(A) Ara Reduction	(H) Yükseklik Height	(T) Kalınlık Thickness	Ürt. Ağırlık Mnf. Weight
Pregalvaniz (PG)	Sıcak Daldırma (HDG)	(mm)	(mm)	(mm)	(kg/adet)
EK RR 40-60 PG	EK RR 40-60 HDG	40	60	1,50	0,38
EK RR 50-60 PG	EK RR 50-60 HDG	50	60	1,50	0,39
EK RR 60-60 PG	EK RR 60-60 HDG	60	60	1,50	0,40
EK RR 80-60 PG	EK RR 80-60 HDG	80	60	1,50	0,41
EK RR 100-60 PG	EK RR 100-60 HDG	100	60	1,50	0,43
EK RR 160-60 PG	EK RR 160-60 HDG	160	60	1,50	0,49
EK RR 200-60 PG	EK RR 200-60 HDG	200	60	1,50	0,51
EK RR 300-60 PG	EK RR 300-60 HDG	300	60	1,50	0,58
EK RR 400-60 PG	EK RR 400-60 HDG	400	60	2,00	0,64
EK RR 500-60 PG	EK RR 500-60 HDG	500	60	2,00	0,71

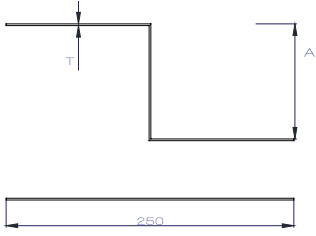

Used with 8 sets of CS M8 Bolt & Nuts each

H:60 Separatör / H:60 Separator

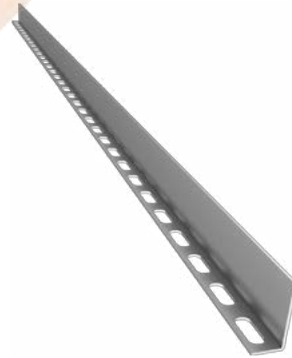
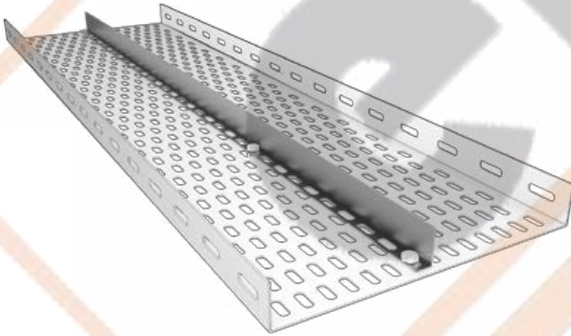

H:60 SEPERATÖR / H:60 SEPARATOR

Ürün Kodu / Product Code		(H) Yükseklik Height	(T) Kalınlık Thickness	Ürt. Ağırlık Mnf. Weight
Pregalvaniz (PG)	Sıcak Daldırma (HDG)	(mm)	(mm)	(kg/adet)
EK SEP 60-10 PG	EK SEP 60-10 HDG	60	1,00	0,59
EK SEP 60-12 PG	EK SEP 60-12 HDG	60	1,20	0,71
EK SEP 60-15 PG	EK SEP 60-15 HDG	60	1,50	0,89

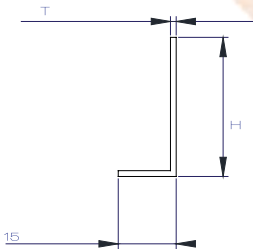

Used with CS M8 Bolt & Nuts

H:60 Sonlandırma / H:60 Stopend

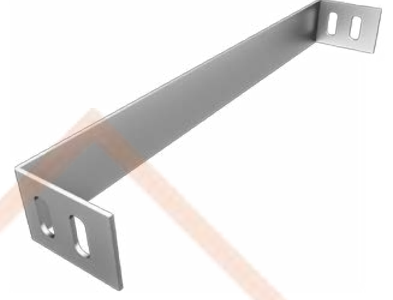
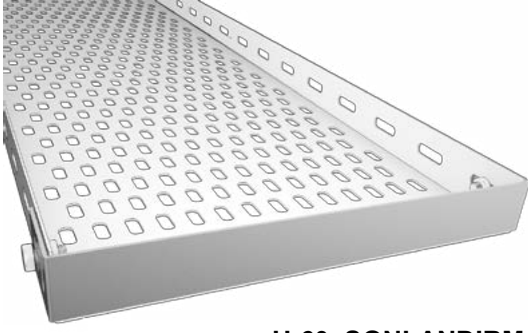

H:60 SONLANDIRMA / H:60 STOPENDS

Ürün Kodu / Product Code		(W) En Width	(H) Yükseklik Height	(T) Kalınlık Thickness	Ürt. Ağırlık Mnf. Weight
Pregalvaniz (PG)	Sıcak Daldırma (HDG)	(mm)	(mm)	(mm)	(kg/adet)
EK SON 50-60 PG	EK SON 50-60 HDG	50	60	1,50	0,14
EK SON 70-60 PG	EK SON 70-60 HDG	70	60	1,50	0,16
EK SON 100-60 PG	EK SON 100-60 HDG	100	60	1,50	0,17
EK SON 120-60 PG	EK SON 120-60 HDG	120	60	1,50	0,18
EK SON 160-60 PG	EK SON 160-60 HDG	160	60	1,50	0,19
EK SON 200-60 PG	EK SON 200-60 HDG	200	60	1,50	0,21
EK SON 260-60 PG	EK SON 260-60 HDG	260	60	1,50	0,24
EK SON 300-60 PG	EK SON 300-60 HDG	300	60	2,00	0,35
EK SON 400-60 PG	EK SON 400-60 HDG	400	60	2,00	0,41
EK SON 500-60 PG	EK SON 500-60 HDG	500	60	2,00	0,47
EK SON 600-60 PG	EK SON 600-60 HDG	600	60	2,00	0,54

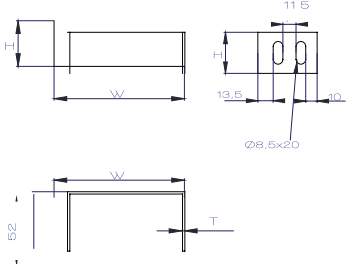

Used with 2 sets of CS M8 Bolt & Nuts

H:60 Dikey Seviye Değişirme / H:60 Vertical Adjustable Connector

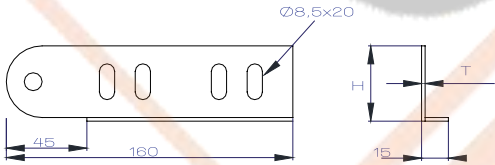
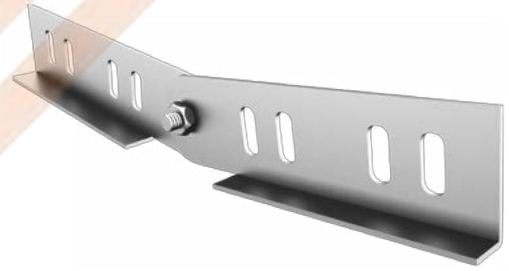
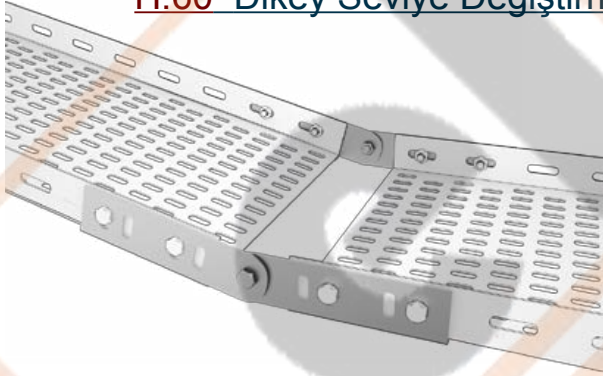

H:60 DİKEY SEVİYE DEĞİŞTİRME / H:60 VERTICAL ADJUSTABLE CONNECTOR

Ürün Kodu		(H) Yükseklik Height	(T) Kalınlık Thickness	Ürt. Ağırlık Mnf. Weight
Pregalvaniz (PG)	Sıcak Daldırma (HDG)	(mm)	(mm)	(kg/adet)
EK SVA 60-12 PG	EK SVA 60-12 HDG	60	1,20	0,25
EK SVA 60-15 PG	EK SVA 60-15 HDG	60	1,50	0,31
EK SVA 60-20 PG	EK SVA 60-20 HDG	60	2,00	0,42

Used with 8 sets of CS M8 Bolt & Nuts each

H:100 KABLO KANALLARI  
H:100 CABLE TRAYS

# H:100 AĞIR HİZMET DELİKLİ KABLO KANALLARI H:100 HEAVY DUTY PERFORATED CABLE TRAYS

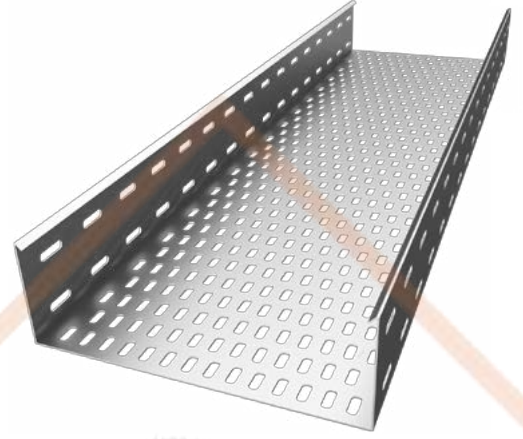
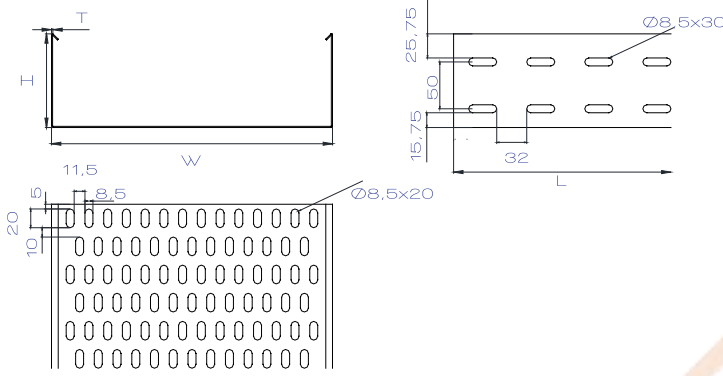

## H:100 AĞIR HİZMET DELİKLİ KABLO KANALLARI / H:100 HEAVY DUTY PERFORATED CABLE TRAYS

Ürün Kodu / Product Code		(W) En Width (mm)	(H) Yükseklik Height (mm)	(T) Kalınlık Thickness (mm)	Ürt. Ağırlık Mnf. Weight (kg/mt)	(L) Boy Length (mm)
Pregalvaniz (PG)	Sıcak Daldırma (HDG)					
EK APK 100-100-10 PG	EK APK 100-100-10 HDG	100	100	1,00	2,51	2500
EK APK 100-100-12 PG	EK APK 100-100-12 HDG	100	100	1,20	3,01	2500
EK APK 100-100-15 PG	EK APK 100-100-15 HDG	100	100	1,50	3,77	2500
EK APK 120-100-10 PG	EK APK 120-100-10 HDG	120	100	1,00	2,67	2500
EK APK 120-100-12 PG	EK APK 120-100-12 HDG	120	100	1,20	3,20	2500
EK APK 120-100-15 PG	EK APK 120-100-15 HDG	120	100	1,50	4,00	2500
EK APK 160-100-10 PG	EK APK 160-100-10 HDG	160	100	1,00	2,98	2500
EK APK 160-100-12 PG	EK APK 160-100-12 HDG	160	100	1,20	3,58	2500
EK APK 160-100-15 PG	EK APK 160-100-15 HDG	160	100	1,50	4,47	2500
EK APK 200-100-10 PG	-	200	100	1,00	3,30	2500
EK APK 200-100-12 PG	-	200	100	1,20	3,96	2500
EK APK 200-100-15 PG	EK APK 200-100-15 HDG	200	100	1,50	4,95	2500
EK APK 200-100-20 PG	EK APK 200-100-20 HDG	200	100	2,00	6,59	2500
EK APK 260-100-12 PG	EK APK 260-100-12 HDG	260	100	1,20	4,52	2500
EK APK 260-100-15 PG	EK APK 260-100-15 HDG	260	100	1,50	5,65	2500
EK APK 260-100-20 PG	EK APK 260-100-20 HDG	260	100	2,00	7,54	2500
EK APK 300-100-12 PG	-	300	100	1,20	4,90	2500
EK APK 300-100-15 PG	EK APK 300-100-15 HDG	300	100	1,50	6,12	2500
EK APK 300-100-20 PG	EK APK 300-100-20 HDG	300	100	2,00	8,16	2500
EK APK 400-100-12 PG	-	400	100	1,20	5,84	2500
EK APK 400-100-15 PG	EK APK 400-100-15 HDG	400	100	1,50	7,30	2500
EK APK 400-100-20 PG	EK APK 400-100-20 HDG	400	100	2,00	9,73	2500
EK APK 500-100-15 PG	EK APK 500-100-15 HDG	500	100	1,50	8,48	2500
EK APK 500-100-20 PG	EK APK 500-100-20 HDG	500	100	2,00	11,30	2500
EK APK 600-100-15 PG	EK APK 600-100-15 HDG	600	100	1,50	9,66	2500
EK APK 600-100-20 PG	EK APK 600-100-20 HDG	600	100	2,00	12,87	2500

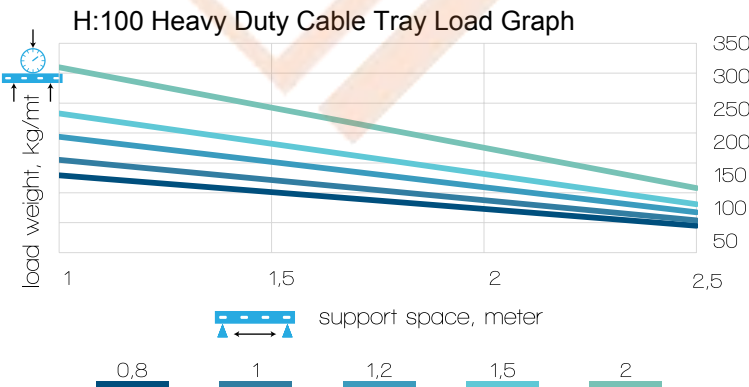

Permissible loads for a maximum deflection of 1/100th of the span, with coupling positioned at 1/5th of the span from support. The coefficient applied to the load for coupling in the middle of the span: 0.7

Safety co-efficient: 1.7

Recommended support distance: 1.5mt

Güvenlik katsayısı: 1,7

Tavsiye edilen destek konsol aralığı: 1,5mt

# H:100 AĞIR HİZMET DELİKSİZ KABLO KANALLARI H:100 HEAVY DUTY NON-PERFORATED CABLE TRAYS

**el-ka**

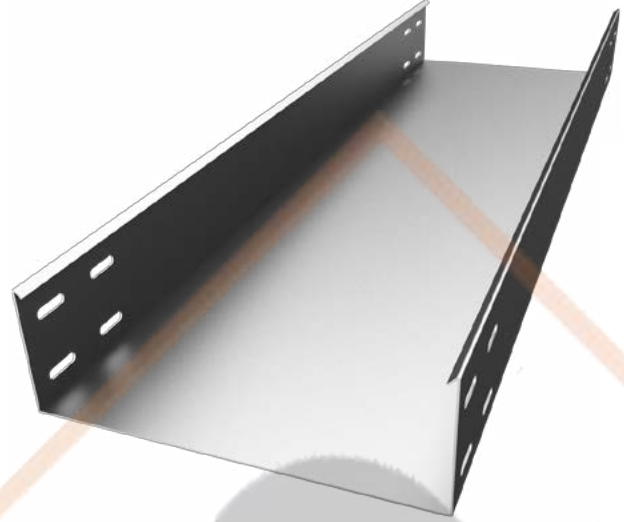
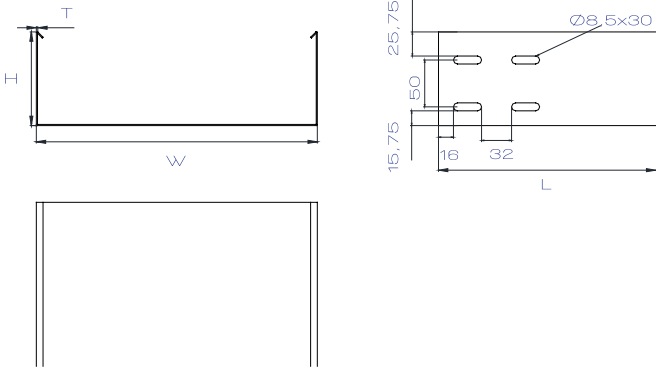

## H:100 AĞIR HİZMET DELİKSİZ KABLO KANALLARI / H:100 HEAVY DUTY NON-PERFORATED CABLE TRAYS

Ürün Kodu / Product Code		(W) En Width (mm)	(H) Yükseklik Height (mm)	(T) Kalınlık Thickness (mm)	Ürt. Ağırlık Mnf. Weight (kg/mt)	(L) Boy Length (mm)
<b>Pregalvaniz (PG)</b>	<b>Sıcak Daldırma (HDG)</b>					
EK ADK 100-100-10 PG	EK ADK 100-100-10 HDG	100	100	1,00	2,51	2500
EK ADK 100-100-12 PG	EK ADK 100-100-12 HDG	100	100	1,20	3,01	2500
EK ADK 100-100-15 PG	EK ADK 100-100-15 HDG	100	100	1,50	3,77	2500
EK ADK 120-100-10 PG	EK ADK 120-100-10 HDG	120	100	1,00	2,67	2500
EK ADK 120-100-12 PG	EK ADK 120-100-12 HDG	120	100	1,20	3,20	2500
EK ADK 120-100-15 PG	EK ADK 120-100-15 HDG	120	100	1,50	4,00	2500
EK ADK 160-100-10 PG	EK ADK 160-100-10 HDG	160	100	1,00	2,98	2500
EK ADK 160-100-12 PG	EK ADK 160-100-12 HDG	160	100	1,20	3,58	2500
EK ADK 160-100-15 PG	EK ADK 160-100-15 HDG	160	100	1,50	4,47	2500
EK ADK 200-100-10 PG	-	200	100	1,00	3,30	2500
EK ADK 200-100-12 PG	-	200	100	1,20	3,96	2500
EK ADK 200-100-15 PG	EK ADK 200-100-15 HDG	200	100	1,50	4,95	2500
EK ADK 200-100-20 PG	EK ADK 200-100-20 HDG	200	100	2,00	6,59	2500
EK ADK 260-100-12 PG	EK ADK 260-100-12 HDG	260	100	1,20	4,52	2500
EK ADK 260-100-15 PG	EK ADK 260-100-15 HDG	260	100	1,50	5,65	2500
EK ADK 260-100-20 PG	EK ADK 260-100-20 HDG	260	100	2,00	7,54	2500
EK ADK 300-100-12 PG	-	300	100	1,20	4,90	2500
EK ADK 300-100-15 PG	EK ADK 300-100-15 HDG	300	100	1,50	6,12	2500
EK ADK 300-100-20 PG	EK ADK 300-100-20 HDG	300	100	2,00	8,16	2500
EK ADK 400-100-12 PG	-	400	100	1,20	5,84	2500
EK ADK 400-100-15 PG	EK ADK 400-100-15 HDG	400	100	1,50	7,30	2500
EK ADK 400-100-20 PG	EK ADK 400-100-20 HDG	400	100	2,00	9,73	2500
EK ADK 500-100-15 PG	EK ADK 500-100-15 HDG	500	100	1,50	8,48	2500
EK ADK 500-100-20 PG	EK ADK 500-100-20 HDG	500	100	2,00	11,30	2500
EK ADK 600-100-15 PG	EK ADK 600-100-15 HDG	600	100	1,50	9,66	2500
EK ADK 600-100-20 PG	EK ADK 600-100-20 HDG	600	100	2,00	12,87	2500

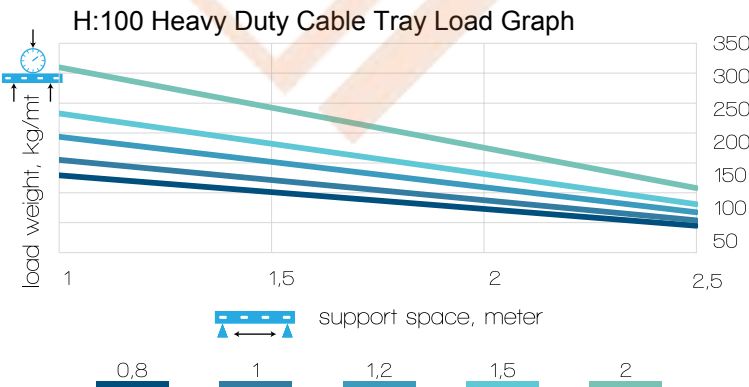

Permissible loads for a maximum deflection of 1/100th of the span, with coupling positioned at 1/5th of the span from support. The coefficient applied to the load for coupling in the middle of the span: 0.7

Safety co-efficient: 1.7

Recommended support distance: 1.5mt

Güvenlik katsayısı: 1,7

Tavsiye edilen destek konsol aralığı: 1,5mt

H:100 Birleştirme Ek Elemanı / H:100 Straight Coupler

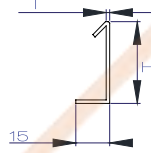
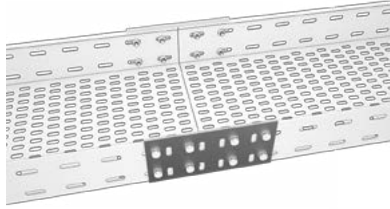
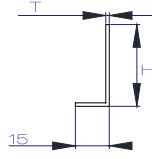
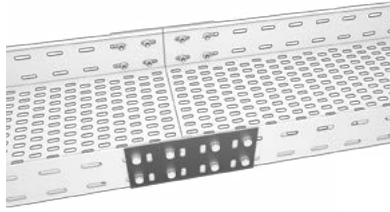

EK SBE

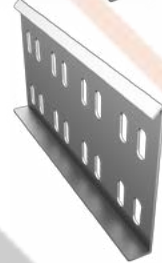

EK BBE

H:100 BİRLEŞTİRME EK ELEMANI / H:100 STRAIGHT CONNECTOR

Ürün Kodu / Product Code		(H) Yükseklik Height (mm)	(T) Kalınlık Thickness (mm)	Ürt. Ağırlık Mnf. Weight (kg/adet)
Pregalvaniz (PG)	Sıcak Daldırma (HDG)			
EK SBE 100-12 PG	EK SBE 100-12 HDG	100	1,20	0,27
EK SBE 100-15 PG	EK SBE 100-15 HDG	100	1,50	0,34
EK BBE 100-12 PG	EK BBE 100-12 HDG	100	1,20	0,29
EK BBE 100-15 PG	EK BBE 100-15 HDG	100	1,50	0,37

M8 CİVATA VE SOMUN / M8 BOLT & NUT



Ürün Kodu / Product Code		Ebat Size (mm)	Ağırlık Weight (kg/adet)
Galvaniz	Dakromet		
CS M8	CS M8 D	M8X15	0,012

Used with 8 sets of CS M8 Bolt & Nuts each

H:100 Yatay Seviye Değişirme / H:100 Horizontal Adjustable Connector

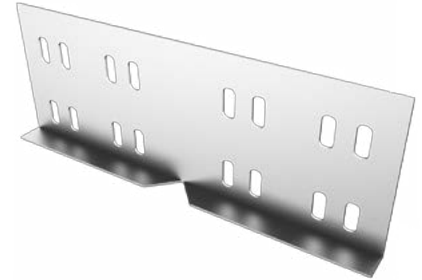
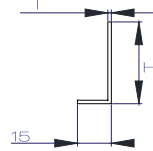
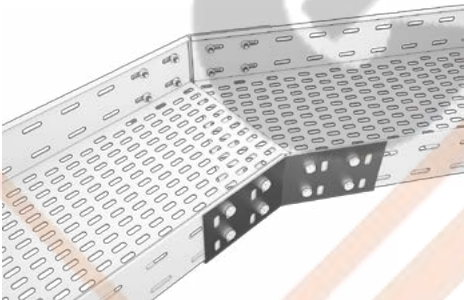

H:100 YATAY SEVİYE DEĞİŞTİRME / H:100 HORIZONTAL ADJUSTABLE CONNECTOR

Ürün Kodu / Product Code		(H) Yükseklik Height (mm)	(T) Kalınlık Thickness (mm)	Ürt. Ağırlık Mnf. Weight (kg/adet)
Pregalvaniz (PG)	Sıcak Daldırma (HDG)			
EK SHA 100-12 PG	EK SHA 100-12 HDG	60	1,20	0,30
EK SHA 100-15 PG	EK SHA 100-15 HDG	60	1,50	0,38
EK SHA 100-20 PG	EK SHA 100-20 HDG	60	2,00	0,51

Used with 8 sets of CS M8 Bolt & Nuts each

H:100 90 Derece Dönüş Elemanı / H:100 Horizontal 90 Degree Bend

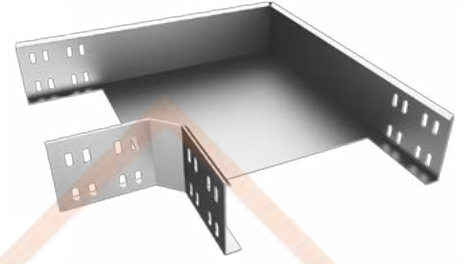

H:100 90 DERECE DÖNÜŞ ELEMANLARI / H:100 HORIZONTAL 90 DEGREE BENDS

Ürün Kodu / Product Code		(W) En Width	(H) Yükseklik Height	(T) Kalınlık Thickness	Urt. Ağırlık Mnf. Weight
Pregalvaniz (PG)	Sıcak Daldırma (HDG)	(mm)	(mm)	(mm)	(kg/adet)
EK K90 100-100 PG	EK K90 100-100 HDG	100	100	1,50	1,58
EK K90 120-100 PG	EK K90 120-100 HDG	120	100	1,50	1,86
EK K90 160-100 PG	EK K90 160-100 HDG	160	100	1,50	1,96
EK K90 200-100 PG	EK K90 200-100 HDG	200	100	1,50	2,32
EK K90 260-100 PG	EK K90 260-100 HDG	260	100	1,50	2,86
EK K90 300-100 PG	EK K90 300-100 HDG	300	100	2,00	4,53
EK K90 400-100 PG	EK K90 400-100 HDG	400	100	2,00	5,99
EK K90 500-100 PG	EK K90 500-100 HDG	500	100	2,00	8,20
EK K90 600-100 PG	EK K90 600-100 HDG	600	100	2,00	10,53

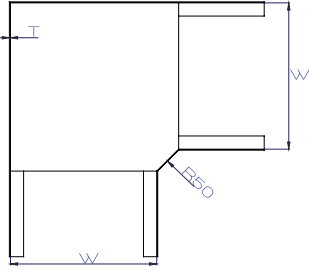

Radius 50

Used with 16 sets of CS M8 Bolt & Nuts each

H:100 T Dönüş Elemanı / H:100 Horizontal Tee Bend

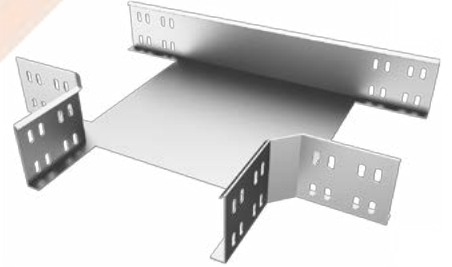
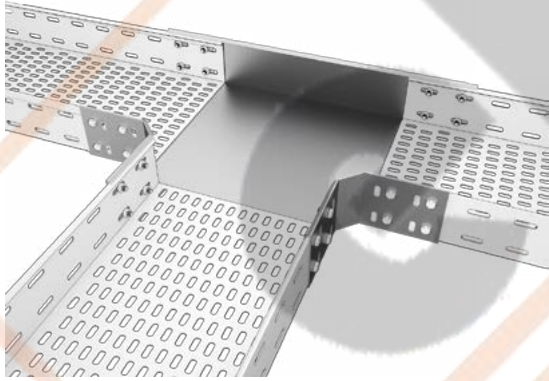

H:100 T DÖNÜŞ ELEMANLARI / H:100 HORIZONTAL TEE BENDS

Ürün Kodu / Product Code		(W) En Width	(H) Yükseklik Height	(T) Kalınlık Thickness	Urt. Ağırlık Mnf. Weight
Pregalvaniz (PG)	Sıcak Daldırma (HDG)	(mm)	(mm)	(mm)	(kg/adet)
EK KT 100-100 PG	EK KT 100-100 HDG	100	100	1,50	2,03
EK KT 120-100 PG	EK KT 120-100 HDG	120	100	1,50	2,27
EK KT 160-100 PG	EK KT 160-100 HDG	160	100	1,50	2,37
EK KT 200-100 PG	EK KT 200-100 HDG	200	100	1,50	2,68
EK KT 260-100 PG	EK KT 260-100 HDG	260	100	1,50	3,28
EK KT 300-100 PG	EK KT 300-100 HDG	300	100	2,00	4,82
EK KT 400-100 PG	EK KT 400-100 HDG	400	100	2,00	6,38
EK KT 500-100 PG	EK KT 500-100 HDG	500	100	2,00	8,25
EK KT 600-100 PG	EK KT 600-100 HDG	600	100	2,00	10,44

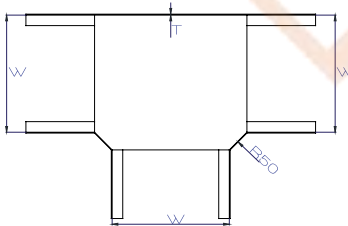

Radius 50

Used with 24 sets of CS M8 Bolt & Nuts each



H:100 Dörtlü Bağlantı Dönüş Elemanı / H:100 Horizontal Crossing

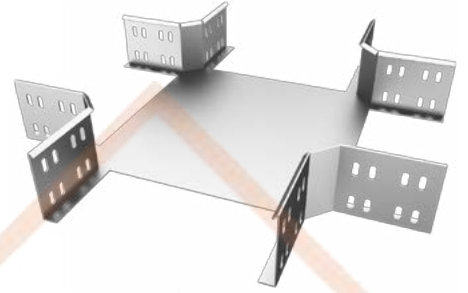

H:100 DÖRTLÜ BAĞLANTI DÖNÜŞ ELEMANLARI / H:100 HORIZONTAL CROSSINGS

Ürün Kodu / Product Code		(W) En Width (mm)	(H) Yükseklik Height (mm)	(T) Kalınlık Thickness (mm)	Urt. Ağırlık Mnf. Weight (kg/adet)
Pregalvaniz (PG)	Sıcak Daldırma (HDG)				
EK KC 100-100 PG	EK KC 100-100 HDG	100	100	1,50	2,53
EK KC 120-100 PG	EK KC 120-100 HDG	120	100	1,50	2,77
EK KC 160-100 PG	EK KC 160-100 HDG	160	100	1,50	2,81
EK KC 200-100 PG	EK KC 200-100 HDG	200	100	1,50	3,12
EK KC 260-100 PG	EK KC 260-100 HDG	260	100	1,50	3,50
EK KC 300-100 PG	EK KC 300-100 HDG	300	100	2,00	5,18
EK KC 400-100 PG	EK KC 400-100 HDG	400	100	2,00	6,59
EK KC 500-100 PG	EK KC 500-100 HDG	500	100	2,00	8,32
EK KC 600-100 PG	EK KC 600-100 HDG	600	100	2,00	10,65

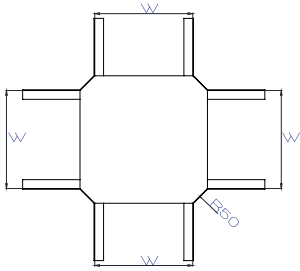

Radius 50

Used with 32 sets of CS M8 Bolt & Nuts each

H:100 45 Derece Dönüş Elemanı / H:100 Horizontal 45 Degree Bend

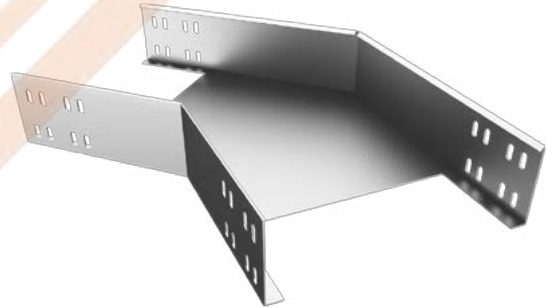
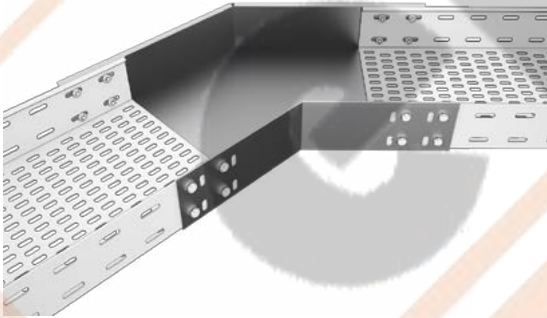

H:100 45 DERECE DÖNÜŞ ELEMANLARI / H:100 HORIZONTAL 45 DEGREE BENDS

Ürün Kodu / Product Code		(W) En Width (mm)	(H) Yükseklik Height (mm)	(T) Kalınlık Thickness (mm)	Urt. Ağırlık Mnf. Weight (kg/adet)
Pregalvaniz (PG)	Sıcak Daldırma (HDG)				
EK K45 100-100 PG	EK K45 100-100 HDG	100	100	1,50	2,79
EK K45 120-100 PG	EK K45 120-100 HDG	120	100	1,50	3,03
EK K45 160-100 PG	EK K45 160-100 HDG	160	100	1,50	3,09
EK K45 200-100 PG	EK K45 200-100 HDG	200	100	1,50	3,35
EK K45 260-100 PG	EK K45 260-100 HDG	260	100	1,50	3,70
EK K45 300-100 PG	EK K45 300-100 HDG	300	100	2,00	5,65
EK K45 400-100 PG	EK K45 400-100 HDG	400	100	2,00	7,03
EK K45 500-100 PG	EK K45 500-100 HDG	500	100	2,00	8,45
EK K45 600-100 PG	EK K45 600-100 HDG	600	100	2,00	10,09

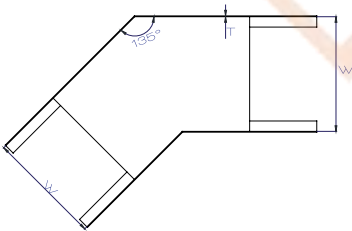

Used with 16 sets of CS M8 Bolt & Nuts each

H:100 Dış Bükey Dönüş Elemanı / H:100 Vertical Outside Bend

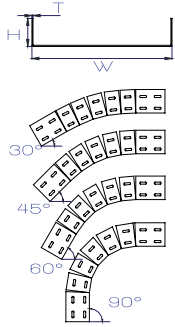
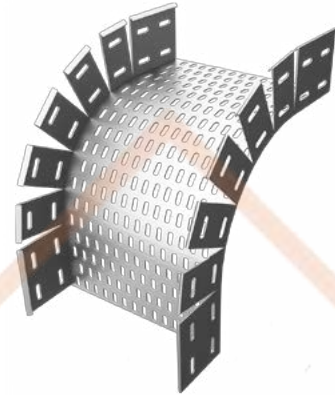
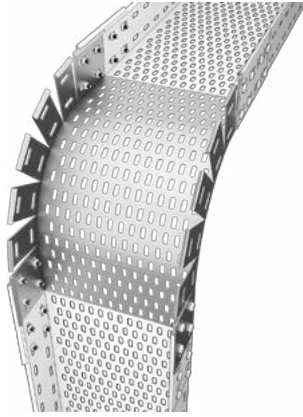

H:100 DIŞ BÜKEY DÖNÜŞ ELEMANLARI / H:100 VERTICAL OUTSIDE BENDS

Ürün Kodu / Product Code		(W) En Width (mm)	(H) Yükseklik Height (mm)	(T) Kalınlık Thickness (mm)	Ürt. Ağırlık Mnf. Weight (kg/adet)
Pregalvaniz (PG)	Sıcak Daldırma (HDG)				
EK KDB 100-100 PG	EK KDB 100-100 HDG	100	100	1,20	1,81
EK KDB 120-100 PG	EK KDB 120-100 HDG	120	100	1,20	1,92
EK KDB 160-100 PG	EK KDB 160-100 HDG	160	100	1,20	2,15
EK KDB 200-100 PG	EK KDB 200-100 HDG	200	100	1,50	2,97
EK KDB 260-100 PG	EK KDB 260-100 HDG	260	100	1,50	3,39
EK KDB 300-100 PG	EK KDB 300-100 HDG	300	100	2,00	4,90
EK KDB 400-100 PG	EK KDB 400-100 HDG	400	100	2,00	7,30
EK KDB 500-100 PG	EK KDB 500-100 HDG	500	100	2,00	8,48
EK KDB 600-100 PG	EK KDB 600-100 HDG	600	100	2,00	9,65

Used with 4 connectors & 16 sets of CS M8 Bolt & Nuts each

Vertical Bend delivered in plain position & may be used for 30-90 degree bendings

H:100 İç Bükey Dönüş Elemanı / H:100 Vertical Inside Bend

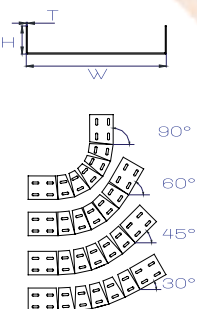
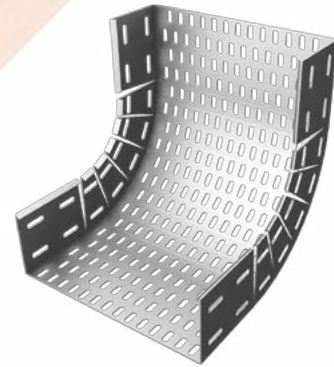
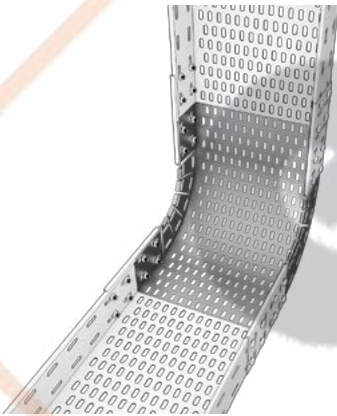

H:100 İÇ BÜKEY DÖNÜŞ ELEMANLARI / H:100 VERTICAL INSIDE BENDS

Ürün Kodu / Product Code		(W) En Width (mm)	(H) Yükseklik Height (mm)	(T) Kalınlık Thickness (mm)	Ürt. Ağırlık Mnf. Weight (kg/adet)
Pregalvaniz (PG)	Sıcak Daldırma (HDG)				
EK KIB 100-100 PG	EK KIB 100-100 HDG	100	100	1,20	1,81
EK KIB 120-100 PG	EK KIB 120-100 HDG	120	100	1,20	1,92
EK KIB 160-100 PG	EK KIB 160-100 HDG	160	100	1,20	2,15
EK KIB 200-100 PG	EK KIB 200-100 HDG	200	100	1,50	2,97
EK KIB 260-100 PG	EK KIB 260-100 HDG	260	100	1,50	3,39
EK KIB 300-100 PG	EK KIB 300-100 HDG	300	100	2,00	4,90
EK KIB 400-100 PG	EK KIB 400-100 HDG	400	100	2,00	7,30
EK KIB 500-100 PG	EK KIB 500-100 HDG	500	100	2,00	8,48
EK KIB 600-100 PG	EK KIB 600-100 HDG	600	100	2,00	9,65

Used with 4 connectors & 16 sets of CS M8 Bolt & Nuts each

Vertical Bend delivered in plain position & may be used for 30-90 degree bendings

H:100 Redüksiyon Elemanı ( Orta ) / H:100 Middle Reducer Connector Set

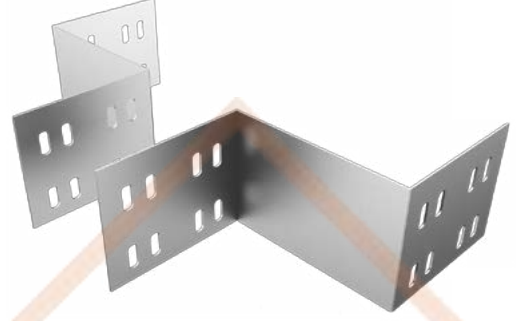
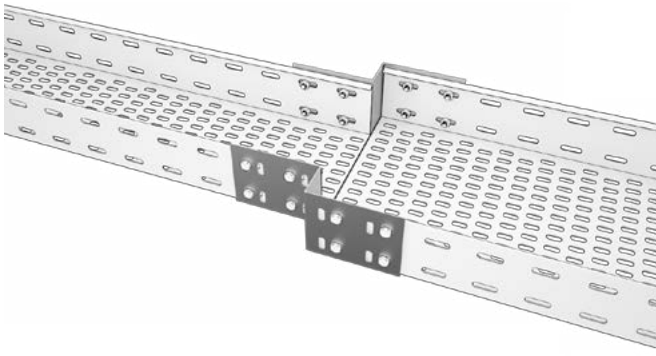

H:100 REDÜKSİYON ELEMANLARI ( ORTA ) / H:100 MIDDLE REDUCER CONNECTOR SET

Ürün Kodu / Product Code		(A) Ara Reduction	(H) Yükseklik Height	(T) Kalınlık Thickness	Ürt. Ağırlık Mnf. Weight
Pregalvaniz (PG)	Sıcak Daldırma (HDG)	(mm)	(mm)	(mm)	(kg/adet)
EK RO 40-100 PG	EK RO 40-100 HDG	40	100	1,50	0,64
EK RO 50-100 PG	EK RO 50-100 HDG	50	100	1,50	0,65
EK RO 60-100 PG	EK RO 60-100 HDG	60	100	1,50	0,66
EK RO 80-100 PG	EK RO 80-100 HDG	80	100	1,50	0,69
EK RO 100-100 PG	EK RO 100-100 HDG	100	100	1,50	0,71
EK RO 160-100 PG	EK RO 160-100 HDG	160	100	1,50	0,78
EK RO 200-100 PG	EK RO 200-100 HDG	200	100	1,50	0,83
EK RO 300-100 PG	EK RO 300-100 HDG	300	100	1,50	0,95
EK RO 400-100 PG	EK RO 400-100 HDG	400	100	1,50	1,07
EK RO 500-100 PG	EK RO 500-100 HDG	500	100	1,50	1,18

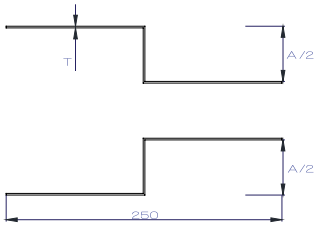

Used with 16 sets of CS M8 Bolt & Nuts each

H:100 Redüksiyon Elemanı ( Sol ) / H:100 Left Reducer Connector Set

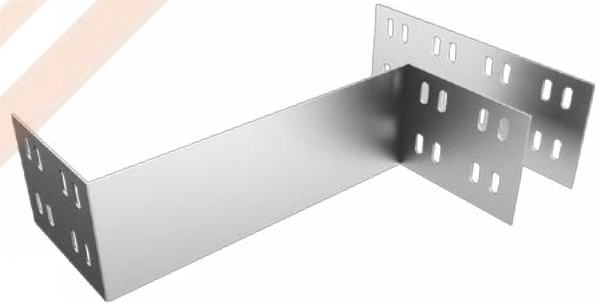
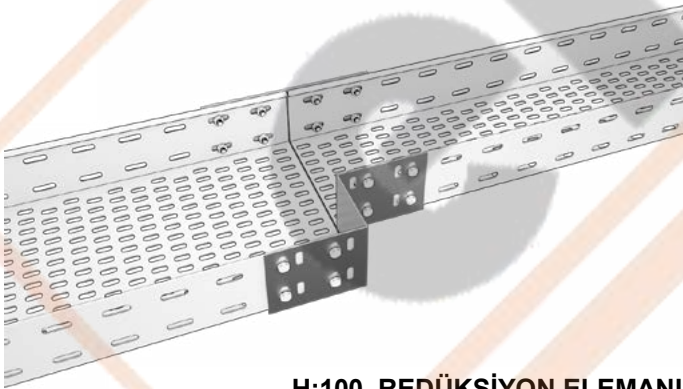

H:100 REDÜKSİYON ELEMANLARI ( SOL ) / H:100 LEFT REDUCER CONNECTOR SET

Ürün Kodu / Product Code		(A) Ara Reduction	(H) Yükseklik Height	(T) Kalınlık Thickness	Ürt. Ağırlık Mnf. Weight
Pregalvaniz (PG)	Sıcak Daldırma (HDG)	(mm)	(mm)	(mm)	(kg/adet)
EK RL 40-100 PG	EK RL 40-100 HDG	40	100	1,50	0,64
EK RL 50-100 PG	EK RL 50-100 HDG	50	100	1,50	0,65
EK RL 60-100 PG	EK RL 60-100 HDG	60	100	1,50	0,66
EK RL 80-100 PG	EK RL 80-100 HDG	80	100	1,50	0,69
EK RL 100-100 PG	EK RL 100-100 HDG	100	100	1,50	0,71
EK RL 160-100 PG	EK RL 160-100 HDG	160	100	1,50	0,78
EK RL 200-100 PG	EK RL 200-100 HDG	200	100	1,50	0,83
EK RL 300-100 PG	EK RL 300-100 HDG	300	100	1,50	0,95
EK RL 400-100 PG	EK RL 400-100 HDG	400	100	1,50	1,07
EK RL 500-100 PG	EK RL 500-100 HDG	500	100	1,50	1,18

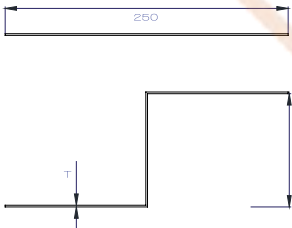

Used with 16 sets of CS M8 -Bolt & Nuts each

H:100 Redüksiyon Elemanı ( Sağ ) / H:100 Right Reducer Connector Set

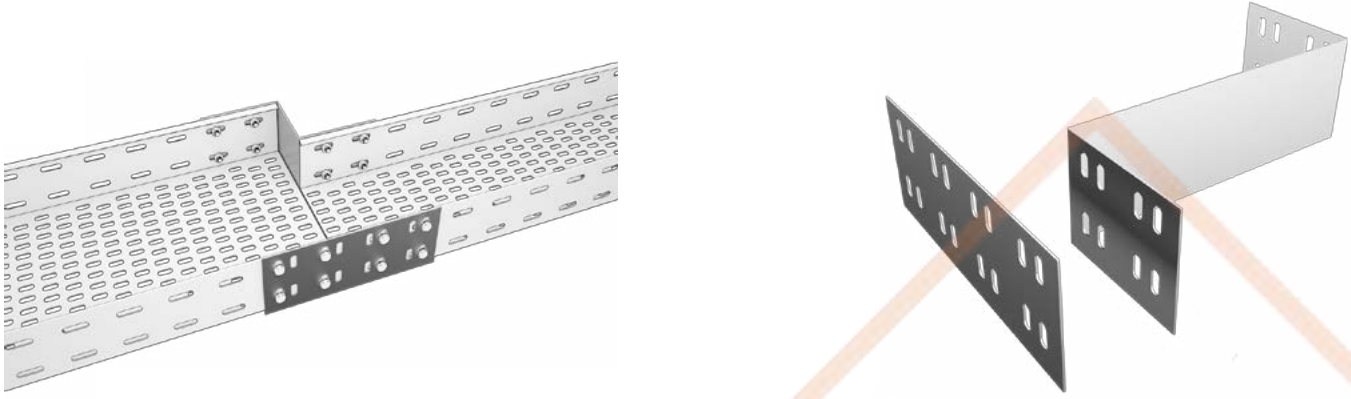

H:100 REDÜKSİYON ELEMANLARI ( SAĞ ) / H:100 RIGHT REDUCER CONNECTOR SET

Ürün Kodu / Product Code		(A) Ara Reduction	(H) Yükseklik Height	(T) Kalınlık Thickness	Ürt. Ağırlık Mnf. Weight
Pregalvaniz (PG)	Sıcak Daldırma (HDG)	(mm)	(mm)	(mm)	(kg/adet)
EK RR 40-100 PG	EK RR 40-100 HDG	40	100	1,50	0,64
EK RR 50-100 PG	EK RR 50-100 HDG	50	100	1,50	0,65
EK RR 60-100 PG	EK RR 60-100 HDG	60	100	1,50	0,66
EK RR 80-100 PG	EK RR 80-100 HDG	80	100	1,50	0,69
EK RR 100-100 PG	EK RR 100-100 HDG	100	100	1,50	0,71
EK RR 160-100 PG	EK RR 160-100 HDG	160	100	1,50	0,78
EK RR 200-100 PG	EK RR 200-100 HDG	200	100	1,50	0,83
EK RR 300-100 PG	EK RR 300-100 HDG	300	100	1,50	0,95
EK RR 400-100 PG	EK RR 400-100 HDG	400	100	2,00	1,07
EK RR 500-100 PG	EK RR 500-100 HDG	500	100	2,00	1,18

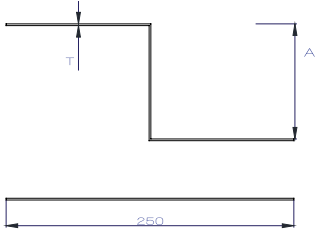

Used with 16 sets of CS M8 Bolt & Nuts each

H:100 Separatör / H:100 Separator



H:100 SEPERATÖR / H:100 SEPARATOR

Ürün Kodu / Product Code		(H) Yükseklik Height	(T) Kalınlık Thickness	Ürt. Ağırlık Mnf. Weight
Pregalvaniz (PG)	Sıcak Daldırma (HDG)	(mm)	(mm)	(kg/adet)
EK SEP 100-10 PG	EK SEP 100-10 HDG	100	1,00	0,91
EK SEP 100-12 PG	EK SEP 100-12 HDG	100	1,20	1,09
EK SEP 100-15 PG	EK SEP 100-15 HDG	100	1,50	1,37

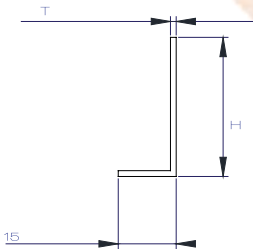

Used with CS M8 Bolt & Nuts

H:100 Sonlandırma / H:100 Stopend

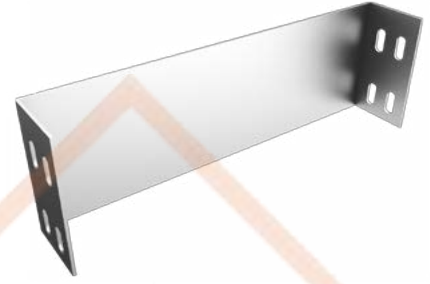

H:100 SONLANDIRMA / H:100 STOPENDS

Ürün Kodu / Product Code		(W) En Width	(H) Yükseklik Height	(T) Kalınlık Thickness	Ürt. Ağırlık Mnf. Weight
Pregalvaniz (PG)	Sıcak Daldırma (HDG)	(mm)	(mm)	(mm)	(kg/adet)
EK SON 100-100 PG	EK SON 100-100 HDG	100	100	1,50	0,42
EK SON 120-100 PG	EK SON 120-100 HDG	120	100	1,50	0,46
EK SON 160-100 PG	EK SON 160-100 HDG	160	100	1,50	0,49
EK SON 200-100 PG	EK SON 200-100 HDG	200	100	1,50	0,53
EK SON 260-100 PG	EK SON 260-100 HDG	260	100	1,50	0,59
EK SON 300-100 PG	EK SON 300-100 HDG	300	100	2,00	0,87
EK SON 400-100 PG	EK SON 400-100 HDG	400	100	2,00	1,02
EK SON 500-100 PG	EK SON 500-100 HDG	500	100	2,00	1,18
EK SON 600-100 PG	EK SON 600-100 HDG	600	100	2,00	1,81

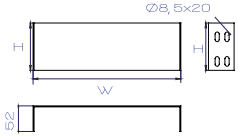

Used with 4 sets of CS M8 Bolt & Nuts

H:100 Dikey Seviye Değişirme / H:100 Vertical Adjustable Connector

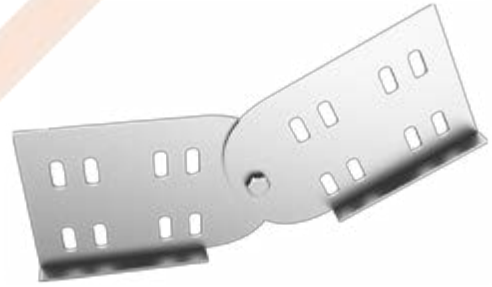
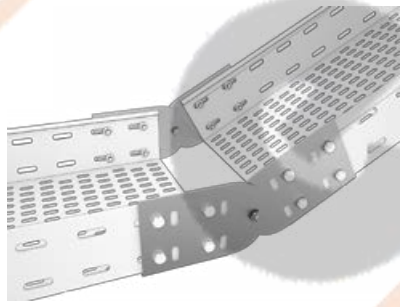

H:100 DİKEY SEVİYE DEĞİŞİRME / H:100 VERTICAL ADJUSTABLE CONNECTOR

Ürün Kodu		(H) Yükseklik Height	(T) Kalınlık Thickness	Ürt. Ağırlık Mnf. Weight
Pregalvaniz (PG)	Sıcak Daldırma (HDG)	(mm)	(mm)	(kg/adet)
EK SVA 100-12 PG	EK SVA 100-12 HDG	100	1,20	0,38
EK SVA 100-15 PG	EK SVA 100-15 HDG	100	1,50	0,48
EK SVA 100-20 PG	EK SVA 100-20 HDG	100	2,00	0,64

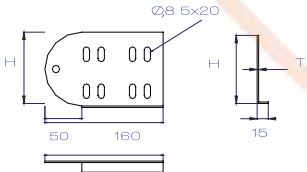

Used with 16 sets of CS M8 Bolt & Nuts each

**DIĐER KABLO KANALI AKSESUARLARI**  
**OTHER ACCESSORIES FOR CABLE TRAYS**

Yatay 90 Derece Dönüş Parçası / Horizontal 90 Degree Bend Add-on

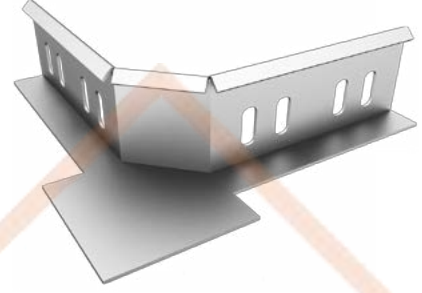
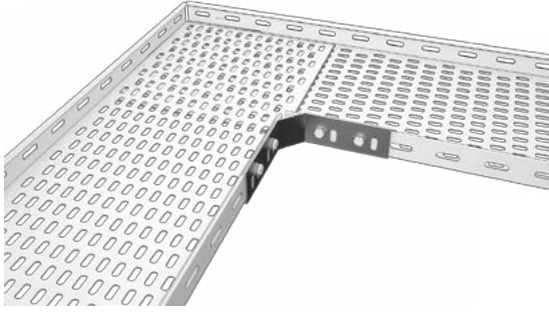

**EK K9A ( W Genişlik ) - ( H Yükseklik )**

Yukarıdaki ürün kodunu belirterek istenilen her ölçüde imal edilmektedir.  
We manufacture all its sizes. Please mention above product code.

Yatay T Dönüş Parçası / Horizontal Tee Bend Add-on

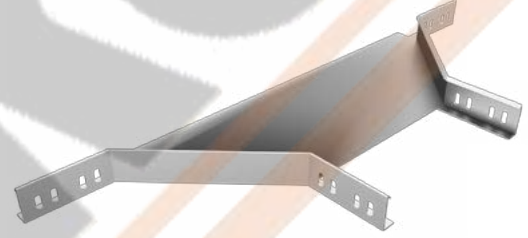
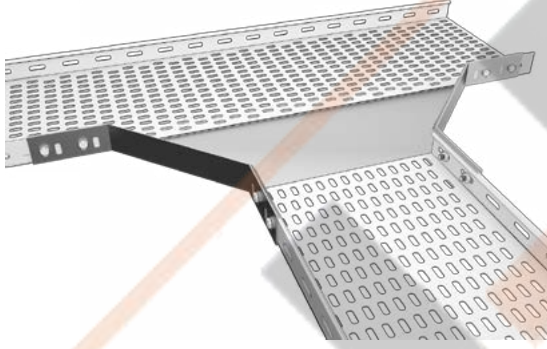

**EK KTA ( W Genişlik ) - ( H Yükseklik )**

Yukarıdaki ürün kodunu belirterek istenilen her ölçüde imal edilmektedir.  
We manufacture all its sizes. Please mention above product code.

Priz - Buat Montaj Çerçevesi / Socket - Box Mounting Frame

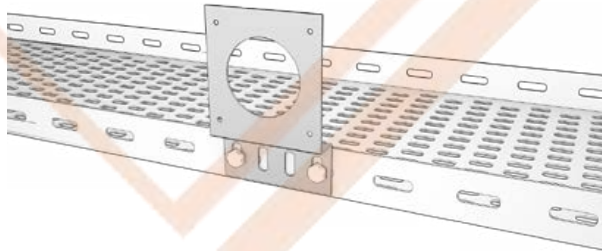

**PRİZ - BUAT MONTAJ ÇERÇEVESİ / SOCKET - BOX MOUNTING FRAME**

Ürün Kodu / Product Code	Ebat Size (mm)	Ağırlık Weight (kg/adet)
Galvaniz EK PMC	1,5	0,33

Ortadan Redüksiyon ( Kaynaklı ) / Middle Reduction ( Welded )

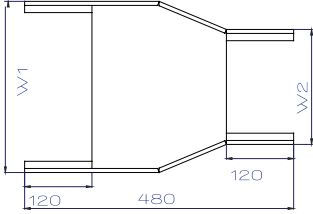
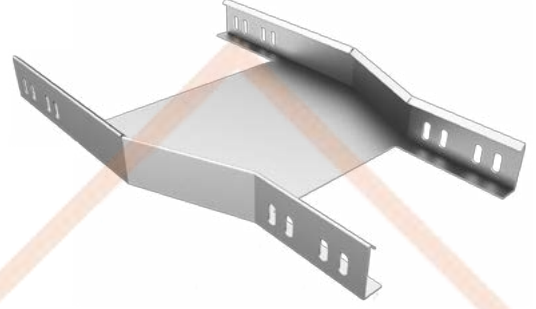

**EK KRO ( W1 Genişlik ) - ( W2 Genişlik ) - ( H Yükseklik )**

Yukarıdaki ürün kodunu belirterek istenilen her ölçüde imal edilmektedir.  
We manufacture all its sizes. Please mention above product code.

Soldan Redüksiyon ( Kaynaklı ) / Left Reduction ( Welded )

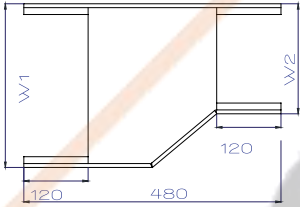
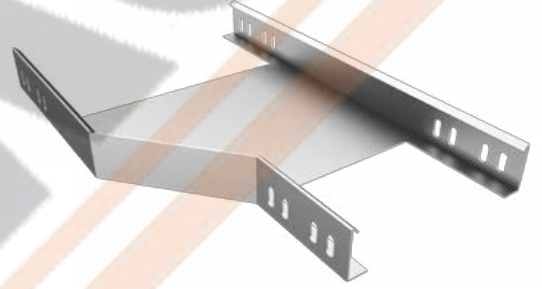

**EK KRL ( W1 Genişlik ) - ( W2 Genişlik ) - ( H Yükseklik )**

Yukarıdaki ürün kodunu belirterek istenilen her ölçüde imal edilmektedir.  
We manufacture all its sizes. Please mention above product code.

Sağdan Redüksiyon ( Kaynaklı ) / Right Reduction ( Welded )

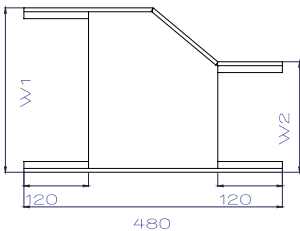
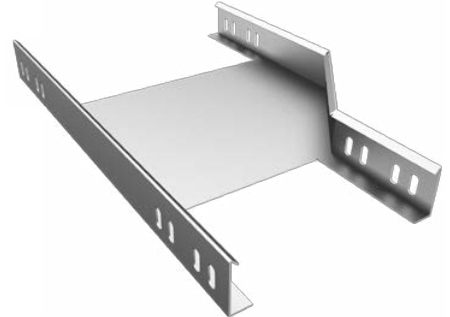
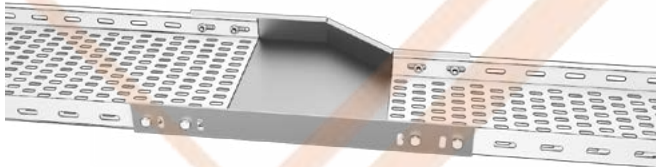

**EK KRR ( W1 Genişlik ) - ( W2 Genişlik ) - ( H Yükseklik )**

Yukarıdaki ürün kodunu belirterek istenilen her ölçüde imal edilmektedir.  
We manufacture all its sizes. Please mention above product code.



Dikey T Dönüş ( Tip 1 ) / Vertical Tee Bend ( Type 1 )



**EK DT1 ( W Genişlik ) - ( H Yükseklik )**

Yukarıdaki ürün kodunu belirterek istenilen her ölçüde imal edilmektedir.  
We manufacture all its sizes. Please mention above product code.

Dikey T Dönüş ( Tip 2 ) / Vertical Tee Bend ( Type 2 )

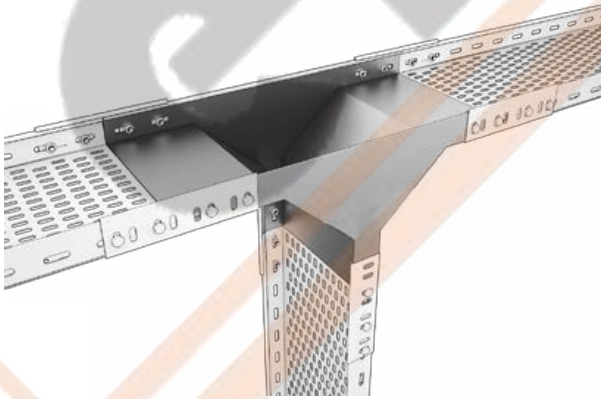

**EK DT2 ( W Genişlik ) - ( H Yükseklik )**

Yukarıdaki ürün kodunu belirterek istenilen her ölçüde imal edilmektedir.  
We manufacture all its sizes. Please mention above product code.

**KABLO KANALI KAPAKLARI**  
**CABLE TRAY COVERS**

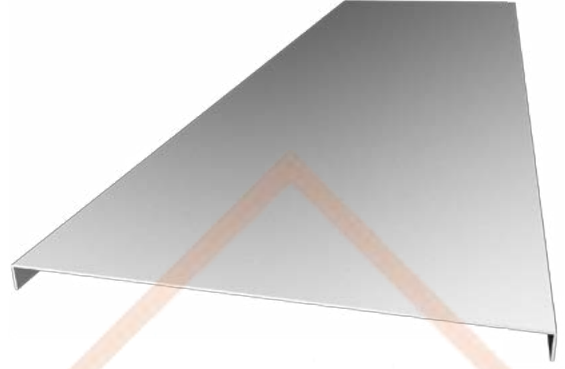
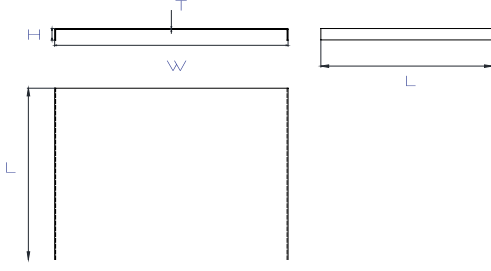

KABLO KANALI KAPAKLARI / CABLE TRAY COVERS

Ürün Kodu / Product Code		(W) En Width	(T) Kalınlık Thickness	Ürt. Ağırlık Mnf. Weight	(L) Boy Length
Pregalvaniz (PG)	Sıcak Daldırma (HDG)	(mm)	(mm)	(kg/mt)	(mm)
EK KMK 50-08 PG	-	50	0,80	0,50	2500
EK KMK 50-10 PG	EK KMK 50-10 HDG	50	1,00	0,63	2500
EK KMK 50-12 PG	EK KMK 50-12 HDG	50	1,20	0,75	2500
EK KMK 50-15 PG	EK KMK 50-15 HDG	50	1,50	0,94	2500
EK KMK 70-08 PG	-	70	0,80	0,63	2500
EK KMK 70-10 PG	EK KMK 70-10 HDG	70	1,00	0,79	2500
EK KMK 70-12 PG	EK KMK 70-12 HDG	70	1,20	0,94	2500
EK KMK 70-15 PG	EK KMK 70-15 HDG	70	1,50	1,18	2500
EK KMK 100-08 PG	-	100	0,80	0,82	2500
EK KMK 100-10 PG	EK KMK 100-10 HDG	100	1,00	1,02	2500
EK KMK 100-12 PG	EK KMK 100-12 HDG	100	1,20	1,22	2500
EK KMK 100-15 PG	EK KMK 100-15 HDG	100	1,50	1,53	2500
EK KMK 120-10 PG	EK KMK 120-10 HDG	120	1,00	1,18	2500
EK KMK 120-12 PG	EK KMK 120-12 HDG	120	1,20	1,41	2500
EK KMK 120-15 PG	EK KMK 120-15 HDG	120	1,50	1,77	2500
EK KMK 160-10 PG	EK KMK 160-10 HDG	160	1,00	1,49	2500
EK KMK 160-12 PG	EK KMK 160-12 HDG	160	1,20	1,79	2500
EK KMK 160-15 PG	EK KMK 160-15 HDG	160	1,50	2,24	2500
EK KMK 200-10 PG	-	200	1,00	1,81	2500
EK KMK 200-12 PG	-	200	1,20	2,17	2500
EK KMK 200-15 PG	EK KMK 200-15 HDG	200	1,50	2,71	2500
EK KMK 200-20 PG	EK KMK 200-20 HDG	200	2,00	3,61	2500
EK KMK 260-12 PG	EK KMK 260-12 HDG	260	1,20	2,73	2500
EK KMK 260-15 PG	EK KMK 260-15 HDG	260	1,50	3,41	2500
EK KMK 260-20 PG	EK KMK 260-20 HDG	260	2,00	4,55	2500
EK KMK 300-12 PG	-	300	1,20	3,11	2500
EK KMK 300-15 PG	EK KMK 300-15 HDG	300	1,50	3,89	2500
EK KMK 300-20 PG	EK KMK 300-20 HDG	300	2,00	5,18	2500
EK KMK 400-12 PG	-	400	1,20	4,05	2500
EK KMK 400-15 PG	EK KMK 400-15 HDG	400	1,50	5,06	2500
EK KMK 400-20 PG	EK KMK 400-20 HDG	400	2,00	6,75	2500
EK KMK 500-15 PG	EK KMK 500-15 HDG	500	1,50	6,24	2500
EK KMK 500-20 PG	EK KMK 500-20 HDG	500	2,00	8,32	2500
EK KMK 600-15 PG	EK KMK 600-15 HDG	600	1,50	7,42	2500
EK KMK 600-20 PG	EK KMK 600-20 HDG	600	2,00	9,89	2500

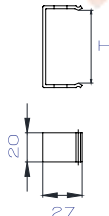

KAPAK TUTUCU / COVER CLAMP

Ürün Kodu / Product Code	Ebat Size	Ağırlık Weight
Galvaniz	(mm)	(kg/adet)
EK KK 40	40	0,031
EK KK 50	50	0,034
EK KK 60	60	0,037
EK KK 70	70	0,039
EK KK 100	100	0,049

Kanal 90° Dönüş Kanal Kapağı / Horizontal Cable Tray 90° Bend Cover

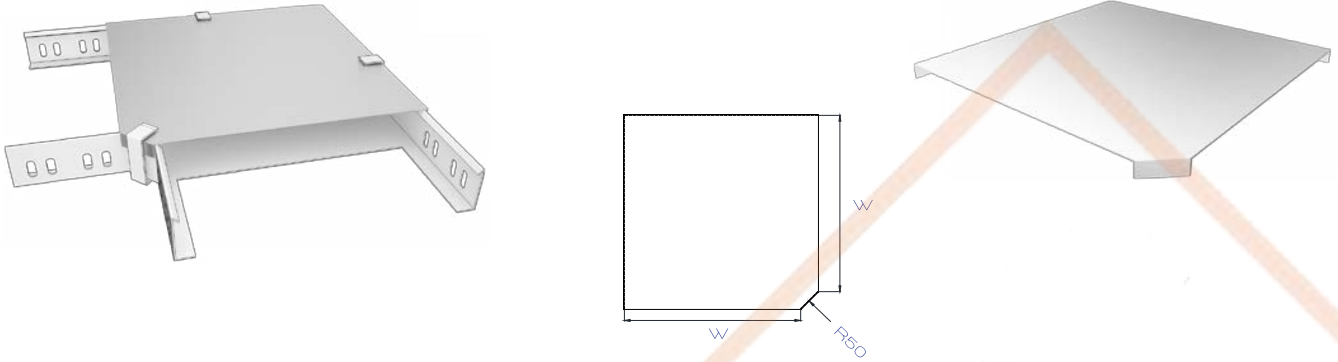

KANAL 90° DÖNÜŞ KAPAĞI / HORIZONTAL CABLE TRAY 90° BEND COVER

Ürün Kodu / Product Code		(W) En Width	(T) Kalınlık Thickness	Urt. Ağırlık Mnf. Weight
Pregalvaniz (PG)	Sıcak Daldırma (HDG)	(mm)	(mm)	(kg/adet)
EK K90K 100 PG	EK K90K 100 HDG	100	1,50	0,32
EK K90K 120 PG	EK K90K 120 HDG	120	1,50	0,45
EK K90K 160 PG	EK K90K 160 HDG	160	1,50	0,56
EK K90K 200 PG	EK K90K 200 HDG	200	1,50	0,83
EK K90K 260 PG	EK K90K 260 HDG	260	1,50	1,19
EK K90K 300 PG	EK K90K 300 HDG	300	1,50	1,57
EK K90K 400 PG	EK K90K 400 HDG	400	1,50	3,39
EK K90K 500 PG	EK K90K 500 HDG	500	1,50	5,01
EK K90K 600 PG	EK K90K 600 HDG	600	1,50	6,94

Kanal T Dönüş Kanal Kapağı / Horizontal Cable Tray Tee Bend Cover

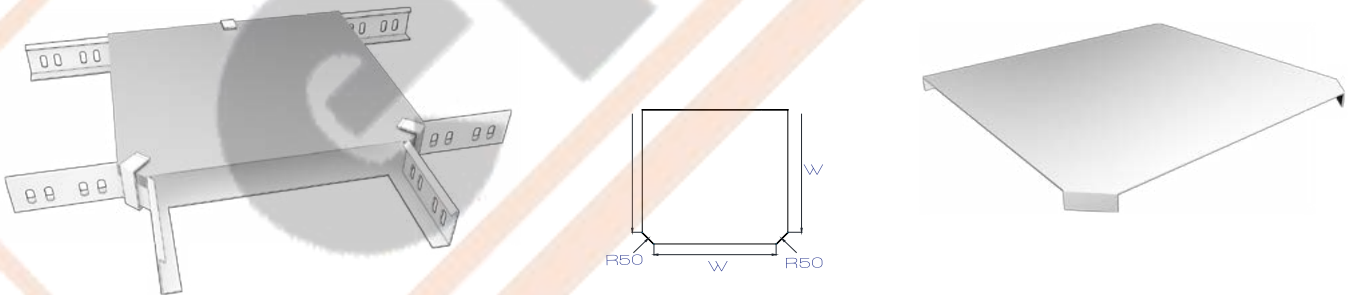

KANAL T DÖNÜŞ KAPAĞI / HORIZONTAL CABLE TRAY TEE BEND COVER

Ürün Kodu / Product Code		(W) En Width	(T) Kalınlık Thickness	Urt. Ağırlık Mnf. Weight
Pregalvaniz (PG)	Sıcak Daldırma (HDG)	(mm)	(mm)	(kg/adet)
EK KTK 100 PG	EK KTK 100 HDG	100	1,50	0,39
EK KTK 120 PG	EK KTK 120 HDG	120	1,50	0,54
EK KTK 160 PG	EK KTK 160 HDG	160	1,50	0,66
EK KTK 200 PG	EK KTK 200 HDG	200	1,50	0,94
EK KTK 260 PG	EK KTK 260 HDG	260	1,50	1,32
EK KTK 300 PG	EK KTK 300 HDG	300	1,50	1,72
EK KTK 400 PG	EK KTK 400 HDG	400	1,50	3,64
EK KTK 500 PG	EK KTK 500 HDG	500	1,50	5,31
EK KTK 600 PG	EK KTK 600 HDG	600	1,50	7,30

Kanal Dörtlü Bağlantı Kapağı / Horizontal Cable Tray Crossing Cover

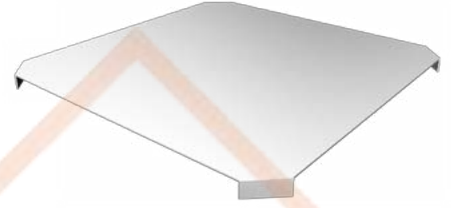
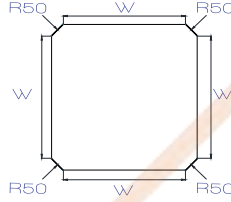
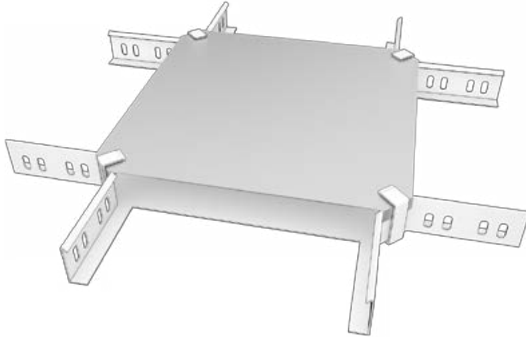

**KANAL DÖRTLÜ BAĞLANTI KAPAĞI / HORIZONTAL CABLE TRAY CROSSING COVER**

Ürün Kodu / Product Code		(W) En Width	(T) Kalınlık Thickness	Ürt. Ağırlık Mnf. Weight
Pregalvaniz (PG)	Sıcak Daldırma (HDG)	(mm)	(mm)	(kg/adet)
EK KCK 100 PG	EK KCK 100 HDG	100	1,50	0,47
EK KCK 120 PG	EK KCK 120 HDG	120	1,50	1,25
EK KCK 160 PG	EK KCK 160 HDG	160	1,50	0,77
EK KCK 200 PG	EK KCK 200 HDG	200	1,50	1,06
EK KCK 260 PG	EK KCK 260 HDG	260	1,50	1,47
EK KCK 300 PG	EK KCK 300 HDG	300	1,50	1,88
EK KCK 400 PG	EK KCK 400 HDG	400	1,50	3,91
EK KCK 500 PG	EK KCK 500 HDG	500	1,50	5,64
EK KCK 600 PG	EK KCK 600 HDG	600	1,50	7,68

Kanal 45° Dönüş Kanal Kapağı / Horizontal Cable Tray 45° Bend Cover

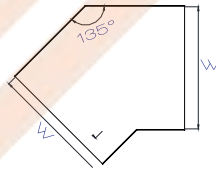
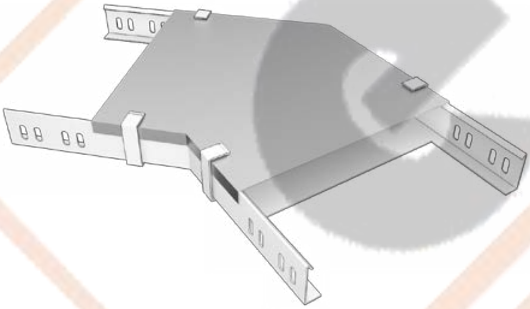

**KANAL 45° DÖNÜŞ KAPAĞI / HORIZONTAL CABLE TRAY 45° BEND COVER**

Ürün Kodu / Product Code		(W) En Width	(T) Kalınlık Thickness	Ürt. Ağırlık Mnf. Weight
Pregalvaniz (PG)	Sıcak Daldırma (HDG)	(mm)	(mm)	(kg/adet)
EK K45K 100 PG	EK K45K 100 HDG	100	1,50	0,58
EK K45K 120 PG	EK K45K 120 HDG	120	1,50	0,73
EK K45K 160 PG	EK K45K 160 HDG	160	1,50	0,85
EK K45K 200 PG	EK K45K 200 HDG	200	1,50	1,11
EK K45K 260 PG	EK K45K 260 HDG	260	1,50	1,48
EK K45K 300 PG	EK K45K 300 HDG	300	1,50	1,81
EK K45K 400 PG	EK K45K 400 HDG	400	1,50	3,56
EK K45K 500 PG	EK K45K 500 HDG	500	1,50	4,94
EK K45K 600 PG	EK K45K 600 HDG	600	1,50	6,54

Kanal Dış Bükey Kapağı / Vertical Cable Tray Outside Bend Cover

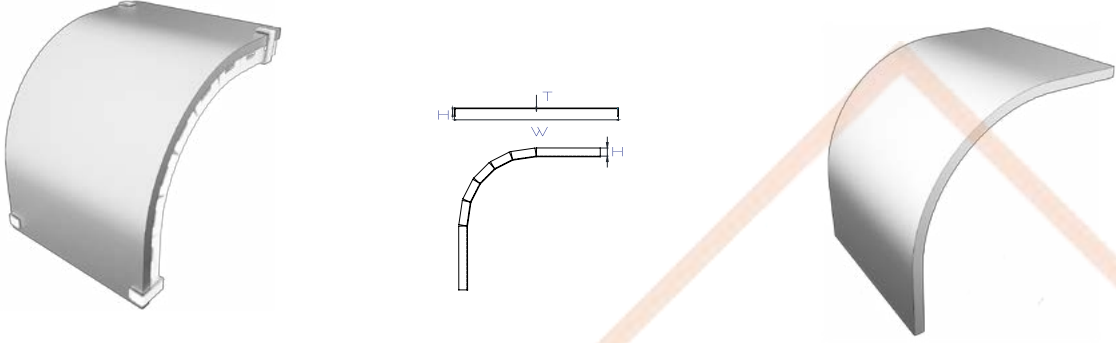

**KANAL DIŞ BÜKEY KAPAĞI / VERTICAL CABLE TRAY OUTSIDE BEND COVER**

Ürün Kodu / Product Code		(W) En Width	(T) Kalınlık Thickness	Ürt. Ağırlık Mnf. Weight
Pregalvaniz (PG)	Sıcak Daldırma (HDG)	(mm)	(mm)	(kg/adet)
EK KDBK 100 PG	EK KDBK 100 HDG	100	1,00	0,73
EK KDBK 120 PG	EK KDBK 120 HDG	120	1,00	0,85
EK KDBK 160 PG	EK KDBK 160 HDG	160	1,20	1,07
EK KDBK 200 PG	EK KDBK 200 HDG	200	1,20	1,30
EK KDBK 260 PG	EK KDBK 260 HDG	260	1,50	2,05
EK KDBK 300 PG	EK KDBK 300 HDG	300	1,50	2,33
EK KDBK 400 PG	EK KDBK 400 HDG	400	1,50	3,80
EK KDBK 500 PG	EK KDBK 500 HDG	500	1,50	4,68
EK KDBK 600 PG	EK KDBK 600 HDG	600	1,50	5,56

Kanal İç Bükey Kapağı / Vertical Cable Tray Inside Bend Cover

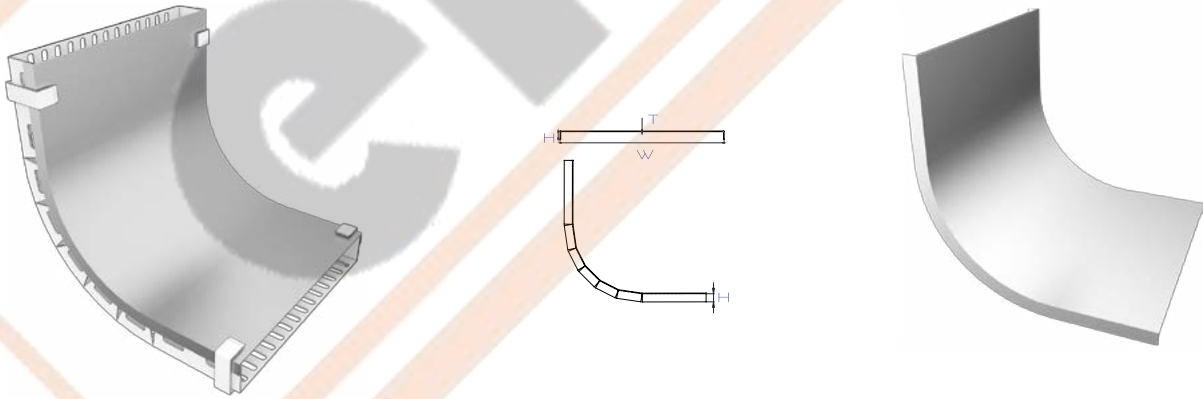

**KANAL İÇ BÜKEY KAPAĞI / VERTICAL CABLE TRAY INSIDE BEND COVER**

Ürün Kodu / Product Code		(W) En Width	(T) Kalınlık Thickness	Ürt. Ağırlık Mnf. Weight
Pregalvaniz (PG)	Sıcak Daldırma (HDG)	(mm)	(mm)	(kg/adet)
EK KIBK 100 PG	EK KIBK 100 HDG	100	1,00	0,73
EK KIBK 120 PG	EK KIBK 120 HDG	120	1,00	0,85
EK KIBK 160 PG	EK KIBK 160 HDG	160	1,20	1,07
EK KIBK 200 PG	EK KIBK 200 HDG	200	1,20	1,30
EK KIBK 260 PG	EK KIBK 260 HDG	260	1,50	2,05
EK KIBK 300 PG	EK KIBK 300 HDG	300	1,50	2,33
EK KIBK 400 PG	EK KIBK 400 HDG	400	1,50	3,80
EK KIBK 500 PG	EK KIBK 500 HDG	500	1,50	4,68
EK KIBK 600 PG	EK KIBK 600 HDG	600	1,50	5,56

Kanal Ortadan Redüksiyon ( Kaynaklı ) Kapağı / Middle Reduction ( Welded ) Cover

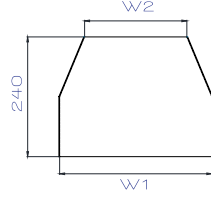
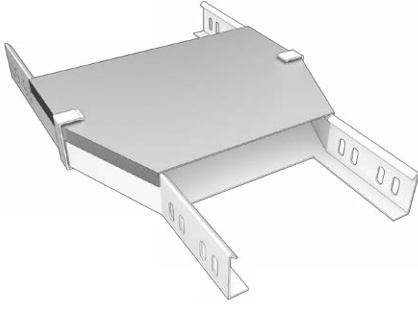

**EK KROK ( W1 Genişlik ) - ( W2 Genişlik )**

Yukarıdaki ürün kodunu belirterek istenilen her ölçüde imal edilmektedir.  
We manufacture all its sizes. Please mention above product code.

Kanal Soldan Redüksiyon ( Kaynaklı ) Kapağı / Left Reduction ( Welded ) Cover

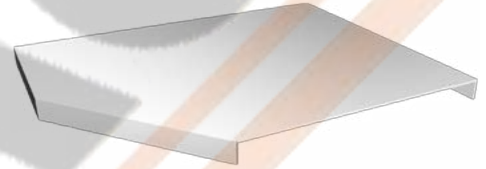
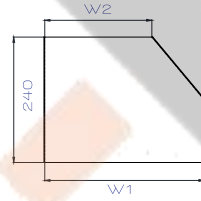
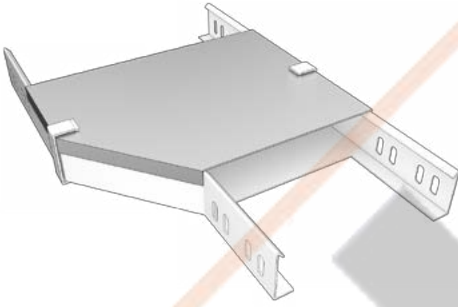

**EK KRLK ( W1 Genişlik ) - ( W2 Genişlik )**

Yukarıdaki ürün kodunu belirterek istenilen her ölçüde imal edilmektedir.  
We manufacture all its sizes. Please mention above product code.

Kanal Sağdan Redüksiyon ( Kaynaklı ) Kapağı / Right Reduction ( Welded ) Cover

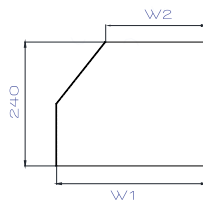
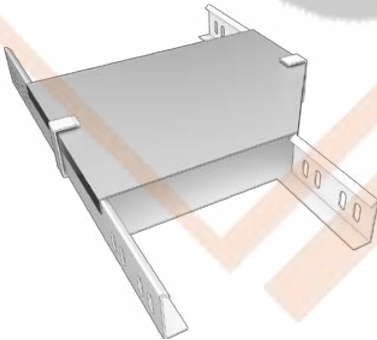

**EK KRRK ( W1 Genişlik ) - ( W2 Genişlik )**

Yukarıdaki ürün kodunu belirterek istenilen her ölçüde imal edilmektedir.  
We manufacture all its sizes. Please mention above product code.