

Kaynaksız Duvar Konsolu / Wall Bracket

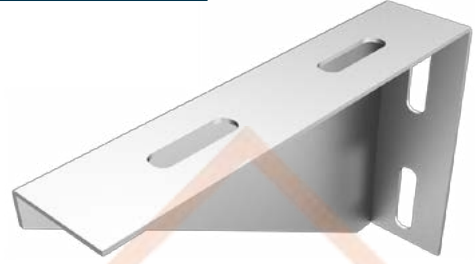
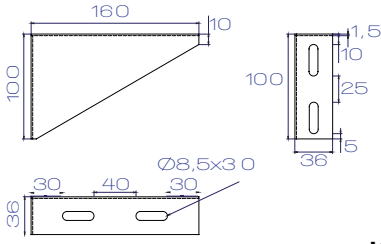

KAYNAKSIZ DUVAR KONSOLU / WALL BRACKET

Ürün Kodu / Product Code		(L) Boy Length	(T) Kalınlık Thickness	(W) Ağırlık Weight
Pregalvaniz (PG)	Sıcak Daldırma (HDG)	(mm)	(mm)	(kg/adet)
EK DK 05 PG	EK DK 05 HDG	50	1,50	0,11
EK DK 10 PG	EK DK 10 HDG	100	1,50	0,19
EK DK 16 PG	EK DK 16 HDG	160	1,50	0,26
EK DK 20 PG	EK DK 20 HDG	200	1,50	0,31
EK DK 30 PG	EK DK 30 HDG	300	2,00	0,71
EK DK 40 PG	EK DK 40 HDG	400	2,00	0,91
EK DK 50 PG	EK DK 50 HDG	500	2,00	1,10
EK DK 60 PG	EK DK 60 HDG	600	2,00	1,31

Kaynaklı Duvar Konsolu / Wall Bracket (Welded)

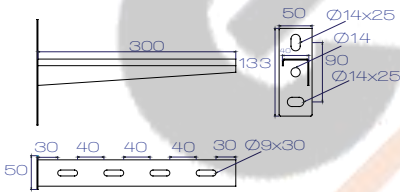
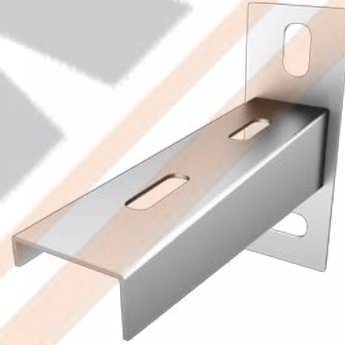
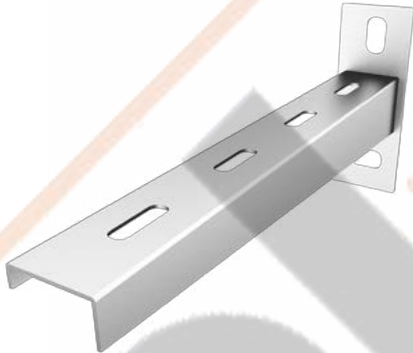

L: 300-600mm base

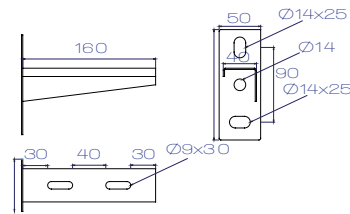

L: 50-260mm base

KAYNAKLI DUVAR KONSOLU / WALL BRACKET (WELDED)

Ürün Kodu / Product Code		(L) Boy Length	(T) Kalınlık Thickness	(W) Ürt. Ağırlık Mnf. Weight
Pregalvaniz (PG)	Sıcak Daldırma (HDG)	(mm)	(mm)	(kg/adet)
EK DKK 05 PG	EK DKK 05 HDG	50	1,50	0,18
EK DKK 10 PG	EK DKK 10 HDG	100	1,50	0,23
EK DKK 16 PG	EK DKK 16 HDG	160	1,50	0,29
EK DKK 20 PG	EK DKK 20 HDG	200	1,50	0,33
EK DKK 30 PG	EK DKK 30 HDG	300	1,50	0,89
EK DKK 40 PG	EK DKK 40 HDG	400	2,00	1,41
EK DKK 50 PG	EK DKK 50 HDG	500	2,00	1,64
EK DKK 60 PG	EK DKK 60 HDG	600	2,00	1,88

Yere Duvara Tespit Elemanı / Bracket for Floor & Wall Mounting

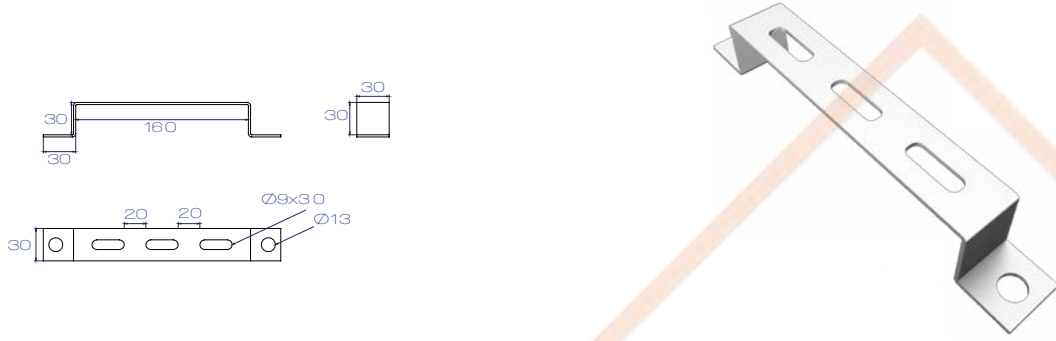

YERE DUVARA TESPİT ELEMANI / BRACKET FOR FLOOR & WALL MOUNTING

Ürün Kodu / Product Code		(L) Boy Length	(T) Kalınlık Thickness	(W) Urt. Ağırlık Mnf. Weight
Pregalvaniz (PG)	Sıcak Daldırma (HDG)	(mm)	(mm)	(kg/adet)
EK YDT 305 PG	EK YDT 305 HDG	50	2,00	0,09
EK YDT 310 PG	EK YDT 310 HDG	100	2,00	0,11
EK YDT 316 PG	EK YDT 316 HDG	160	2,00	0,13
EK YDT 320 PG	EK YDT 320 HDG	200	2,00	0,15
EK YDT 330 PG	EK YDT 330 HDG	300	3,00	0,30
EK YDT 340 PG	EK YDT 340 HDG	400	3,00	0,37
EK YDT 350 PG	EK YDT 350 HDG	500	3,00	0,44
EK YDT 360 PG	EK YDT 360 HDG	600	3,00	0,51

Askı Tiji / Threaded Rod

ASKI TİJİ / THREADED ROD

Ürün Kodu / Product Code	(L) Boy Length (mm)	(D) Çapı Diameter (mm)	(W) Ağırlık Weight (kg/adet)
Galvaniz			
EK TM6 50	500	M6	0,08
EK TM6 100	1000	M6	0,15
EK TM6 200	2000	M6	0,30
EK TM8 50	500	M8	0,15
EK TM8 100	1000	M8	0,30
EK TM8 200	2000	M8	0,60
EK TM10 50	500	M10	0,24
EK TM10 100	1000	M10	0,48
EK TM10 200	2000	M10	0,96
EK TM12 50	500	M12	0,34
EK TM12 100	1000	M12	0,68
EK TM12 200	2000	M12	1,36



Uzatma Somunu / Threaded Rod Coupler (Extension Nut)



UZATMA SOMUNU / THREADED ROD COUPLER

Ürün Kodu / Product Code	(D) Çapı Diameter (mm)	(W) Ağırlık Weight (kg/adet)
Galvaniz		
EK TUS M6	M6	0,01
EK TUS M8	M8	0,02
EK TUS M10	M10	0,03
EK TUS M12	M12	0,04

Tij Tavan Tespitler / Threaded Rod Hanging Headplates

Tavan Tespit (U Tipi)
Threaded Rod Head Plate (U Type)

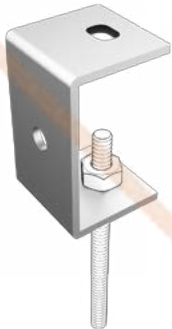

EK TT-01

Tavan Tespit (Omega Tipi)
Threaded Rod Head Plate (Omega Type)

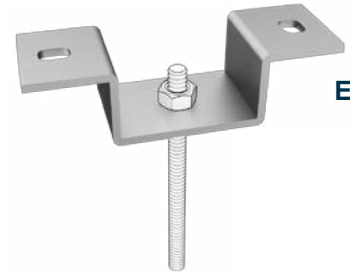

EK TT-02

Tavan Tespit (V Tipi)
Threaded Rod Headplate (V Type)



EK TT-03

Tek Tijli Kanal Taşıyıcı / Single-Rod Tray Carrier

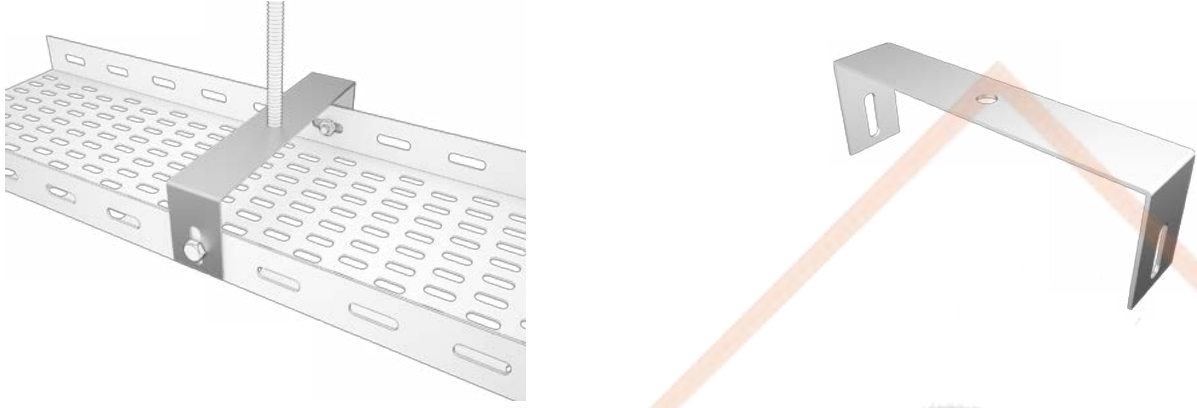

TEK TİJLİ KANAL TAŞIYICI / SINGLE-ROD TRAY CARRIER

Ürün Kodu / Product Code		(L) Boy Length	(T) Kalınlık Thickness	(W) Ağırlık Weight
Pregalvaniz (PG)	Sıcak Daldırma (HDG)	(mm)	(mm)	(kg/adet)
EK TK1 50 PG	EK TK1 50 HDG	55	1,50	0,10
EK TK1 100 PG	EK TK1 100 HDG	105	1,50	0,14
EK TK1 160 PG	EK TK1 160 HDG	165	1,50	0,18
EK TK1 200 PG	EK TK1 200 HDG	205	2,00	0,20
EK TK1 300 PG	EK TK1 300 HDG	305	2,00	0,39
EK TK1 400 PG	EK TK1 400 HDG	405	2,00	0,49

Çift Tijli Kanal Taşıyıcı (L Tipi) / Double-Rod Tray Carrier (L Type)

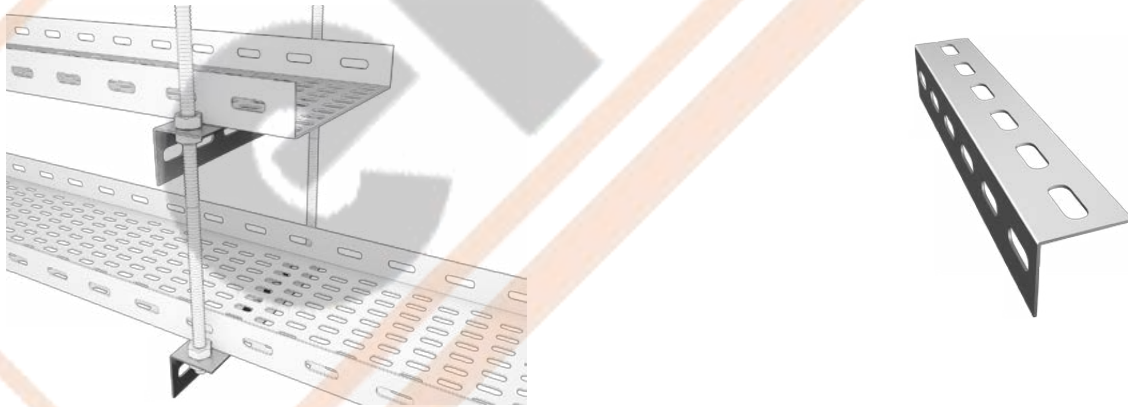

ÇİFT TİJLİ KANAL TAŞIYICI (L TİPİ) / DOUBLE-ROD TRAY CARRIER (L TYPE)

Ürün Kodu / Product Code		(L) Boy Length	(T) Kalınlık Thickness	(W) Ağırlık Weight
Pregalvaniz (PG)	Sıcak Daldırma (HDG)	(mm)	(mm)	(kg/adet)
EK TK2 160 PG	EK TK2 160 HDG	220	1,50	0,22
EK TK2 200 PG	EK TK2 200 HDG	260	1,50	0,26
EK TK2 300 PG	EK TK2 300 HDG	360	1,50	0,36
EK TK2 400 PG	EK TK2 400 HDG	460	1,50	0,45
EK TK2 500 PG	EK TK2 500 HDG	560	1,50	0,55
EK TK2 600 PG	EK TK2 600 HDG	660	1,50	0,65

Çift Tıjlı Kanal Taşıyıcı (U Tipi) / Double-Rod Tray Carrier (U Type)



ÇİFT TİJLİ KANAL TAŞIYICI (U TİPİ) / DOUBLE-ROD TRAY CARRIER (U TYPE)

Ürün Kodu / Product Code		(L) Boy Length	(T) Kalınlık Thickness	(W) Ağırlık Weight
Pregalvaniz (PG)	Sıcak Daldırma (HDG)	(mm)	(mm)	(kg/adet)
EK TK3 160 PG	EK TK3 160 HDG	220	2,00	0,37
EK TK3 200 PG	EK TK3 200 HDG	260	2,00	0,44
EK TK3 300 PG	EK TK3 300 HDG	360	2,00	0,60
EK TK3 400 PG	EK TK3 400 HDG	460	2,00	0,77
EK TK3 500 PG	EK TK3 500 HDG	560	2,00	0,94
EK TK3 600 PG	EK TK3 600 HDG	660	2,00	1,10

Tek Tıjlı Kanal Taşıyıcı (C Tipi) / Single-Rod Tray Carrier (C Type)



TEK TİJLİ KANAL TAŞIYICI (C TİPİ) / SINGLE-ROD TRAY CARRIER (C TYPE)

Ürün Kodu / Product Code		(L) Boy Length	(T) Kalınlık Thickness	(W) Ağırlık Weight
Pregalvaniz (PG)	Sıcak Daldırma (HDG)	(mm)	(mm)	(kg/adet)
EK TK5 50 PG	EK TK5 50 HDG	60	3,00	0,19
EK TK5 100 PG	EK TK5 100 HDG	110	3,00	0,24
EK TK5 160 PG	EK TK5 160 HDG	170	3,00	0,29
EK TK5 200 PG	EK TK5 200 HDG	210	3,00	0,32

Askı Mengenesi (Döküm) / Support Hanger Clamp (Cast)



ASKI MENGENESİ (DÖKÜM) / SUPPORT HANGER CLAMP (CAST)

Ürün Kodu / Product Code	(D) Delik Çapı Thickness	(W) Ağırlık Weight
	(mm)	(kg/adet)
Döküm EK PAM-1	9	0,19
EK PAM-2	11	0,18
EK PAM-3	13	0,17

U PROFIL DESTEK SİSTEMLERİ
U PROFILE SUPPORT SYSTEMS

U Profil Destek (30x50) / U Profile Support (Cut & Use)

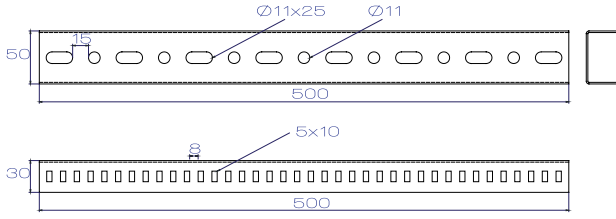

Standard Length(L) 2500mm / On request 500-3000mm

U PROFİL DESTEK (30x50) / U PROFILE SUPPORT (30x50) (CUT & USE)

Ürün Kodu / Product Code		(L) Boy Length	(T) Kalınlık Thickness	(W) Ağırlık Weight
Pregalvaniz (PG)	Sıcak Daldırma (HDG)	(mm)	(mm)	(kg/mt)
EK U 3050 12 PG	EK U 3050 12 HDG	2500	1,20	1,04
EK U 3050 15 PG	EK U 3050 15 HDG	2500	1,50	1,30
EK U 3050 20 PG	EK U 3050 20 HDG	2500	2,00	1,73

U Profil Kaynaklı Tavan Tespit / U Profile Hanging Support (Welded)

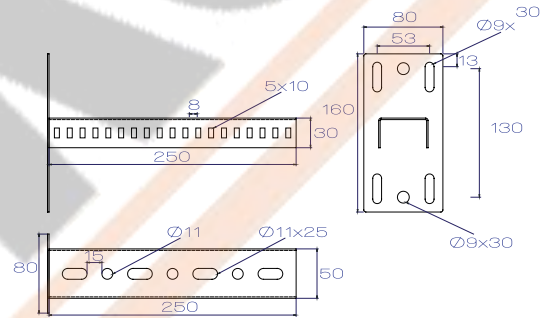
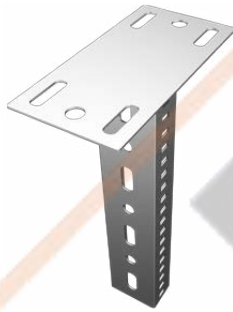

U PROFİL KAYNAKLI TAVAN TESPİT / U PROFILE HANGING SUPPORT (WELDED)

Ürün Kodu / Product Code		(L) Boy Length	(T) Kalınlık Thickness	(W) Ağırlık Weight
Pregalvaniz (PG)	Sıcak Daldırma (HDG)	(mm)	(mm)	(kg/adet)
EK UT1 10 PG	EK UT1 10 HDG	100	2,00	0,49
EK UT1 25 PG	EK UT1 25 HDG	250	2,00	0,75
EK UT1 50 PG	EK UT1 50 HDG	500	2,00	1,20
EK UT1 75 PG	EK UT1 75 HDG	750	2,00	1,65
EK UT1 100 PG	EK UT1 100 HDG	1000	2,00	2,10
EK UT1 150 PG	EK UT1 150 HDG	1500	2,00	3,00

Çiftli U Profil Kaynaklı Tavan Tespit / Double U Profile Ceiling Support

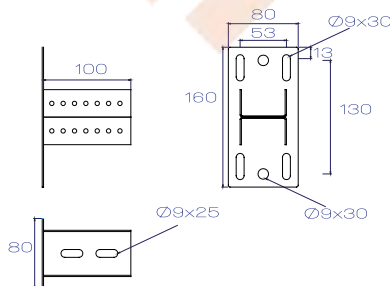

EK UTD-10



Çift U Profil Bağlantı Parçası / Double U Profile Connector

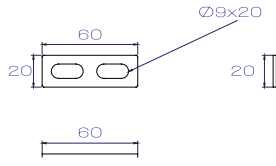

EK UE



Order code for 1 pcs, please order 2 pcs as minimum usage.
Ürün kodu 1 adet ürün içindir. En az kullanım için 2 adet sipariş veriniz.

U Profil Sıvama Konsol / U Profile Bracket

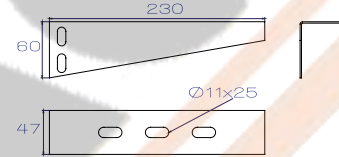
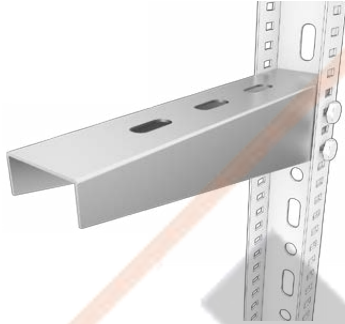

U PROFİL SIVAMA KONSOL / U PROFILE BRACKET

Ürün Kodu / Product Code		(L) Boy Length	(T) Kalınlık Thickness	(W) Ağırlık Weight
Pregalvaniz (PG)	Sıcak Daldırma (HDG)	(mm)	(mm)	(kg/adet)
EK UK 10 PG	EK UK 10 HDG	100	1,50	0,28
EK UK 16 PG	EK UK 16 HDG	160	1,50	0,41
EK UK 20 PG	EK UK 20 HDG	200	1,50	0,50
EK UK 30 PG	EK UK 30 HDG	300	2,00	0,65
EK UK 40 PG	EK UK 40 HDG	400	2,00	0,85
EK UK 50 PG	EK UK 50 HDG	500	2,00	1,10
EK UK 60 PG	EK UK 60 HDG	600	2,00	1,25

U Profil Ayarlı Tavan Tespit / U Profile Adjustable Ceiling Support

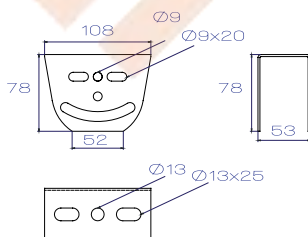

EK UT2 03

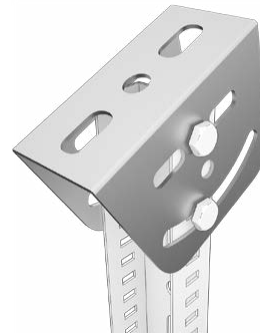

U Profil Ayarlı Tavan Tespit (L Tipi) / U Profile Adjustable Ceiling Support (L Type)

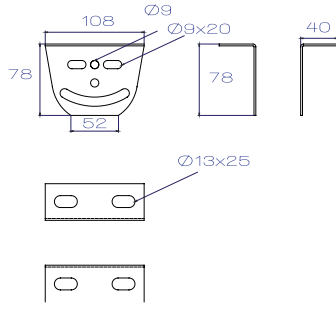

EK UT2 04

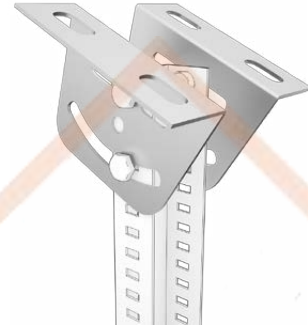

Order code for 1 pcs, please order 2 pcs as minimum usage.
Ürün kodu 1 adet ürün içindir. En az kullanım için 2 adet sipariş veriniz.

U Profil Birleştirme Elemanı / U Profile Coupler

U Profil Birleştirme Elemanı / U Profile Coupler



EK UBE

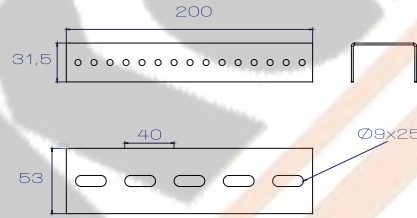

Order code for 1 pcs, please order 2 pcs as minimum usage.
Ürün kodu 1 adet ürün içindir. En az kullanım için 2 adet sipariş veriniz.

U Destek Taşıma Değerleri / U Support Static Values

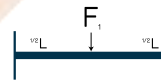
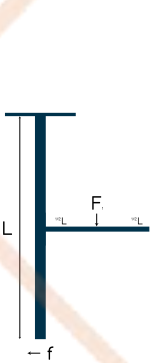

L = 200 mm
F1 = 160 kg
f, mm

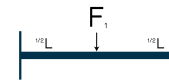

L = 400 mm
F1 = 120 kg
f, mm

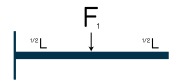

L = 600 mm
F1 = 80 kg
f, mm

Model	L, mm	L = 200 mm F1 = 160 kg f, mm	L = 400 mm F1 = 120 kg f, mm	L = 600 mm F1 = 80 kg f, mm
UT1 50	500	6	6	6
UT1 100	1000	14	14	16
UT1 150	1500	20	20	24

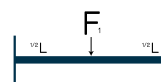

L = 200 mm
f = 0 kg
F1, mm

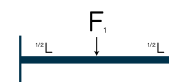

L = 400 mm
f = 0 kg
F1, mm



L = 600 mm
f = 0 kg
F1, mm

Model	L, mm	L = 200 mm f = 0 kg F1, mm	L = 400 mm f = 0 kg F1, mm	L = 600 mm f = 0 kg F1, mm
UT3 50	500	320	240	160
UT3 100	1000	310	230	150
UT3 150	1500	300	220	140
UT3 200	2000	280	200	120

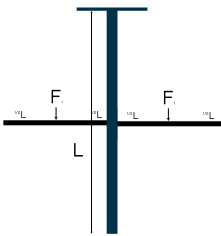

C PROFIL DESTEK SİSTEMLERİ
C CHANNEL SUPPORT SYSTEMS

C Profil Destek 21x41 / C Channel Support 21x41

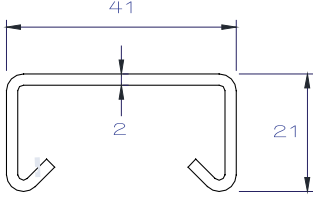

C 2141A

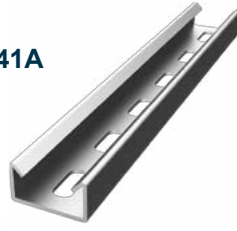

C 2141

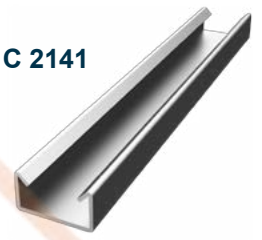

C PROFİL DESTEK (21x41) / C PROFILE SUPPORT (21x41)

Ürün Kodu / Product Code		(L) Boy Length	(T) Kalınlık Thickness	(W) Ağırlık Weight
Pregalvaniz (PG)	Sıcak Daldırma (HDG)	(mm)	(mm)	(kg/m ^t)
EK C 2141 15 PG	EK C 2141 15 HDG	2500	1,50	1,22
EK C 2141 20 PG	EK C 2141 20 HDG	2500	2,00	1,62
EK C 2141A 15 PG	EK C 2141A 15 HDG	2500	1,50	1,21
EK C 2141A 20 PG	EK C 2141A 20 HDG	2500	2,00	1,62

Standard Length: L:2500mm / on request any size from 150mm upto 3000mm
Standart Boy: L:2500mm / Sipariş üzerine 150mm-3000mm arası imalat yapılır.

C Profil Destek 41x41 / C Channel Support 41x41

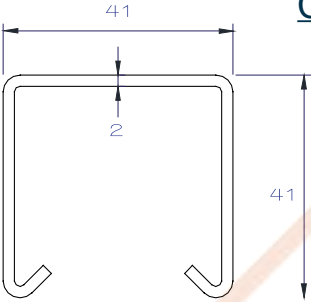

C 4141A



C 4141

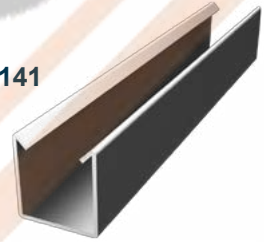

C PROFİL DESTEK (41x41) / C PROFILE SUPPORT (41x41)

Ürün Kodu / Product Code		(L) Boy Length	(T) Kalınlık Thickness	(W) Ürt. Ağırlık Mnf. Weight
Pregalvaniz (PG)	Sıcak Daldırma (HDG)	(mm)	(mm)	(kg/m ^t)
EK C 4141 15 PG	EK C 4141 15 HDG	2500	1,50	1,69
EK C 4141 20 PG	EK C 4141 20 HDG	2500	2,00	2,25
EK C 4141A 15 PG	EK C 4141A 15 HDG	2500	1,50	1,69
EK C 4141A 20 PG	EK C 4141A 20 HDG	2500	2,00	2,25
EK C 4141B 15 PG	EK C 4141B 15 HDG	2500	1,50	1,69
EK C 4141B 20 PG	EK C 4141B 20 HDG	2500	2,00	2,25

Standard Length: L:2500mm / on request any size from 150mm upto 3000mm
Standart Boy: L:2500mm / Sipariş üzerine 150mm-3000mm arası imalat yapılır.

C 4141B model has perforation hole 9x30 on three sides
C 4141B kodlu ürün, 3 taraftan 9x30 delikli dir.

C Profil Destek Taşıma Verileri / C Channel Support Static Values

"L" (mm)"	21x41x2			21x41x2,5		41x41x2,0		41x41x2,5	
	"F" (kg)"	"f" (mm)"	"f" (mm)"	"F" (kg)"	"f" (mm)"	"F" (kg)"	"f" (mm)"	"F" (kg)"	"f" (mm)"
250	39,00	0,43	49,00	0,59	90,00	0,37	140,00	0,24	
500	19,50	1,72	24,50	2,35	45,00	1,48	70,00	0,94	
750	13,00	3,87	16,33	5,28	30,00	3,35	46,67	2,12	
1.000	9,75	6,88	12,29	9,39	22,50	5,92	35,00	3,77	
1.250	7,80	10,74	9,80	11,66	18,00	9,26	28,00	5,90	
1.500	6,50	15,47	8,17	21,22	15,00	13,30	23,33	8,49	
1.750	5,57	21,06	7,00	28,74	12,86	18,14	20,00	11,56	
2.000	4,88	27,50	6,13	37,54	11,25	23,70	17,50	15,10	
2.250					10,00	29,94	15,56	19,11	
2.500	-	-	-	-	9,00	37,83	14,00	23,59	

Sırt Sırt C Profil Destek 42x41 / Double C Channel Support 42x41

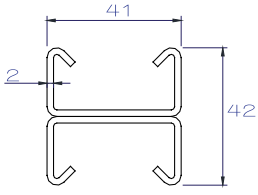

C 4241A



C 4241



C PROFİL DESTEK (42x41) / C PROFILE SUPPORT (42x41)

Ürün Kodu / Product Code		(L) Boy Length	(T) Kalınlık Thickness	(W) Ağırlık Weight
Pregalvaniz (PG)	Sıcak Daldırma (HDG)	(mm)	(mm)	(kg/mt)
EK C 4241 15 PG	EK C 4241 15 HDG	2500	1,50	2,43
EK C 4241 20 PG	EK C 4241 20 HDG	2500	2,00	3,24
EK C 4241A 15 PG	EK C 4241A 15 HDG	2500	1,50	1,21
EK C 4241A 20 PG	EK C 4241A 20 HDG	2500	2,00	2,43

Sırt Sırt C Profil Destek 83x41 / Double C Channel Support 83x41

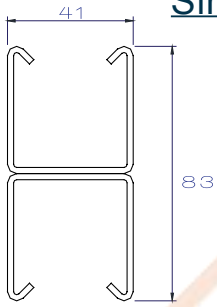

C 8341A

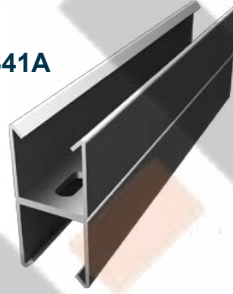

C 8341

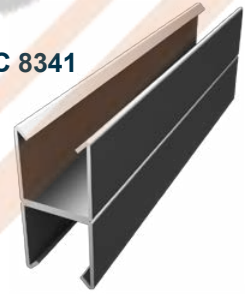

C PROFİL DESTEK (83x41) / C PROFILE SUPPORT (83x41)

Ürün Kodu / Product Code		(L) Boy Length	(T) Kalınlık Thickness	(W) Ürt. Ağırlık Mnf. Weight
Pregalvaniz (PG)	Sıcak Daldırma (HDG)	(mm)	(mm)	(kg/mt)
EK C 8341 15 PG	EK C 8341 15 HDG	2500	1,50	3,37
EK C 8341 20 PG	EK C 8341 20 HDG	2500	2,00	4,49
EK C 8341A 15 PG	EK C 8341A 15 HDG	2500	1,50	3,37
EK C 8341A 20 PG	EK C 8341A 20 HDG	2500	2,00	4,49
EK C 8341B 15 PG	EK C 8341B 15 HDG	2500	1,50	3,37
EK C 8341B 20 PG	EK C 8341B 20 HDG	2500	2,00	4,49

Standard Length: L:2500mm / on request any size from 150mm upto 3000mm
Standart Boy: L:2500mm / Sipariş üzerine 150mm-3000mm arası imalat yapılır.

C 4141B model has perforation hole 9x30 on three sides
C 4141B kodlu ürün, 3 taraftan 9x30 deliklidir.

Sırt Sırt C Profil Destek Taşıma Verileri / Double C Channel Support Static Values

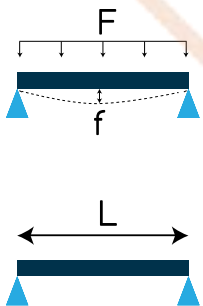

	42x41x2			42x41x2.5		83x41x2		83x41x2.5	
"L" (mm)"	"F" (kg)"	"f" (mm)"	"F" (kg)"	"f" (mm)"	"F" (kg)"	"f" (mm)"	"F" (kg)"	"f" (mm)"	
250	90,00	0,32	140,00	0,20	-	-	-	-	
500	45,00	1,28	70,00	0,82	-	-	-	-	
750	30,00	2,89	46,67	1,84	133,33	1,79	166,70	0,91	
1.000	22,50	5,14	35,00	3,27	100,00	3,17	125,00	1,62	
1.250	18,00	8,02	28,00	5,11	80,00	4,96	100,00	2,54	
1.500	15,00	11,56	23,33	7,36	66,70	7,14	83,33	3,66	
1.750	12,86	15,73	20,00	10,02	57,14	9,72	71,43	4,28	
2.000	11,25	20,54	17,50	13,09	50,00	12,10	62,50	6,50	
2.250	10,00	26,00	15,56	16,57	44,40	16,07	55,56	8,23	
2.500	9,00	30,10	14,00	20,45	40,00	19,84	50,00	10,16	

C Profil Kaynaklı Konsol (21x41) / C Channel Bracket (21x41)

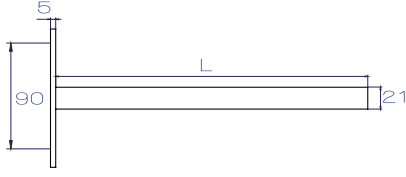

C PROFİL KAYNAKLI KONSOL / C CHANNEL BRACKET

Ürün Kodu / Product Code		(L) Boy Length	(T) Kalınlık Thickness	(W) Ağırlık Weight
Pregalvaniz (PG)	Sıcak Daldırma (HDG)	(mm)	(mm)	(kg/adet)
EK C21 50 PG	EK C21 50 HDG	60	2,00	0,38
EK C21 100 PG	EK C21 100 HDG	110	2,00	0,45
EK C21 160 PG	EK C21 160 HDG	170	2,00	0,53
EK C21 200 PG	EK C21 200 HDG	210	2,00	0,58
EK C21 300 PG	EK C21 300 HDG	310	2,00	0,71
EK C21 400 PG	EK C21 400 HDG	410	2,00	0,84

C Profil Kaynaklı Konsol (41x41) / C Channel Bracket (41x41)

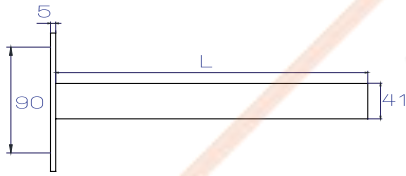

C PROFİL KAYNAKLI KONSOL / C CHANNEL BRACKET

Ürün Kodu / Product Code		(L) Boy Length	(T) Kalınlık Thickness	(W) Ağırlık Weight
Pregalvaniz (PG)	Sıcak Daldırma (HDG)	(mm)	(mm)	(kg/adet)
EK C41 50 PG	EK C41 50 HDG	60	2,00	0,44
EK C41 100 PG	EK C41 100 HDG	110	2,00	0,55
EK C41 160 PG	EK C41 160 HDG	170	2,00	0,69
EK C41 200 PG	EK C41 200 HDG	210	2,00	0,79
EK C41 300 PG	EK C41 300 HDG	310	2,00	1,00
EK C41 400 PG	EK C41 400 HDG	410	2,00	1,22
EK C41 500 PG	EK C41 500 HDG	510	2,00	1,45
EK C41 600 PG	EK C41 600 HDG	610	2,00	1,67

C Profil Konsol Taşıma Verileri / C Channel Bracket Static Values

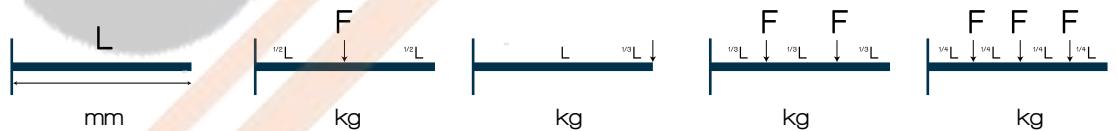

	mm	kg	kg	kg	kg
C21 50	60	280	140	140	93
C21 100	19,50	1,72	24,50	2,35	45,00
C21 160	170	200	100	100	67
C21 200	210	175	88	88	58
C21 300	310	95	48	48	32
C21 400	410	70	35	35	23
C41 50	60	900	450	450	300
C41 100	110	740	370	370	247
C41 160	170	620	310	310	207
C41 200	210	520	260	260	173
C41 300	310	320	160	160	107
C41 400	410	240	120	120	80
C41 500	510	195	98	98	65
C41 600	610	160	80	80	53

C Profil Kaynaklı Konsol (42x41) / C Channel Bracket (42x41)

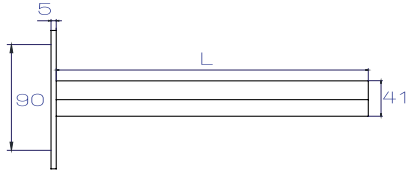

C PROFİL KAYNAKLI KONSOL / C CHANNEL BRACKET

Ürün Kodu / Product Code		(L) Boy Length	(T) Kalınlık Thickness	(W) Ağırlık Weight
Pregalvaniz (PG)	Sıcak Daldırma (HDG)	(mm)	(mm)	(kg/adet)
EK C42 100 PG	EK C42 100 HDG	110	2,00	0,82
EK C42 160 PG	EK C42 160 HDG	170	2,00	1,07
EK C42 200 PG	EK C42 200 HDG	210	2,00	1,23
EK C42 300 PG	EK C42 300 HDG	310	2,00	1,63
EK C42 400 PG	EK C42 400 HDG	410	2,00	2,04
EK C42 500 PG	EK C42 500 HDG	510	2,00	2,44
EK C42 600 PG	EK C42 600 HDG	610	2,00	2,85

C Profil Kaynaklı Konsol (83x41) / C Channel Bracket (83x41)

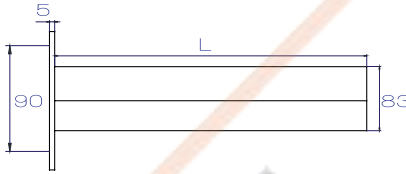

C PROFİL KAYNAKLI KONSOL / C CHANNEL BRACKET

Ürün Kodu / Product Code		(L) Boy Length	(T) Kalınlık Thickness	(W) Ağırlık Weight
Pregalvaniz (PG)	Sıcak Daldırma (HDG)	(mm)	(mm)	(kg/adet)
EK C83 100 PG	EK C83 100 HDG	110	2,00	1,05
EK C83 160 PG	EK C83 160 HDG	170	2,00	1,38
EK C83 200 PG	EK C83 200 HDG	210	2,00	1,61
EK C83 300 PG	EK C83 300 HDG	310	2,00	2,17
EK C83 400 PG	EK C83 400 HDG	410	2,00	2,73
EK C83 500 PG	EK C83 500 HDG	510	2,00	3,29
EK C83 600 PG	EK C83 600 HDG	610	2,00	3,85

C Profil Konsol Taşıma Verileri / C Channel Bracket Static Values

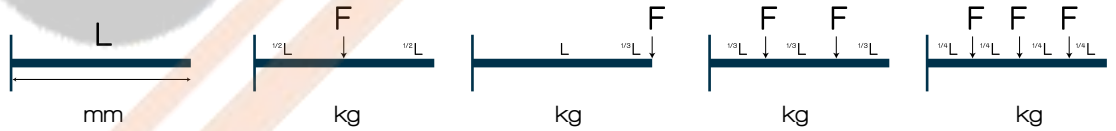

	mm	kg	kg	kg	kg
C42 100	110	700	350	350	233
C42 160	170	600	300	300	200
C42 200	210	500	250	250	167
C42 300	310	300	150	150	100
C42 400	410	240	120	120	80
C42 500	510	186	93	93	62
C42 600	610	150	75	75	50
C83 100	110	990	495	495	330
C83 160	170	880	440	440	293
C83 200	210	700	350	350	233
C83 300	310	660	330	330	220
C83 400	410	520	260	260	173
C83 500	510	400	200	200	133
C83 600	610	340	170	170	113

C Profil Tavan Tespit (21x41) / C Channel Hanging Support (21x41)

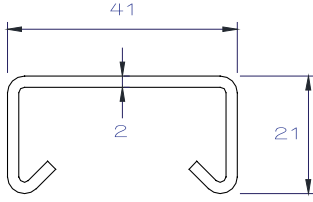

C PROFİL TAVAN TESPİT 21x41 / C CHANNEL HANGING SUPPORT 21x41

Ürün Kodu / Product Code		(L) Boy Length	(T) Kalınlık Thickness	(W) Ağırlık Weight
Pregalvaniz (PG)	Sıcak Daldırma (HDG)	(mm)	(mm)	(kg/adet)
EK CT21 25 PG	EK CT21 25 HDG	250	2,00	1,54
EK CT21 50 PG	EK CT21 50 HDG	500	2,00	1,94
EK CT21 75 PG	EK CT21 75 HDG	750	2,00	2,35
EK CT21 100 PG	EK CT21 100 HDG	1000	2,00	2,75
EK CT21 125 PG	EK CT21 125 HDG	1250	2,00	3,16
EK CT21 150 PG	EK CT21 150 HDG	1500	2,00	3,56

C Profil Tavan Tespit (41x41) / C Channel Hanging Support (41x41)

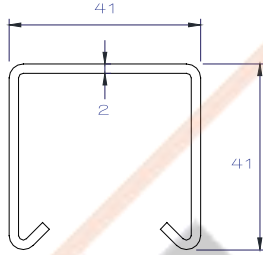

C PROFİL TAVAN TESPİT 41x41 / C CHANNEL HANGING SUPPORT 41x41

Ürün Kodu / Product Code		(L) Boy Length	(T) Kalınlık Thickness	(W) Ağırlık Weight
Pregalvaniz (PG)	Sıcak Daldırma (HDG)	(mm)	(mm)	(kg/adet)
EK CT41 25 PG	EK CT41 25 HDG	250	2,00	1,84
EK CT41 50 PG	EK CT41 50 HDG	500	2,00	2,31
EK CT41 75 PG	EK CT41 75 HDG	750	2,00	2,77
EK CT41 100 PG	EK CT41 100 HDG	1000	2,00	3,28
EK CT41 125 PG	EK CT41 125 HDG	1250	2,00	3,98
EK CT41 150 PG	EK CT41 150 HDG	1500	2,00	4,68

C Profil Tavan Tespit Taşıma Verileri / C Channel Hanging Support Static Values

L	f	L = 100 mm F1 = 150 kg			L = 200 mm F1 = 100 kg			L = 400 mm F1 = 70 kg		
		f	f	f	f	f	f	f	f	
CT21 50	500	5	5	5	5	5	5	5		
CT21 100	1000	12	12	12	12	12	12	12		
CT21 150	1500	17	17	17	17	17	17	17		
		L = 200 mm F1 = 200 kg			L = 400 mm F1 = 140 kg			L = 600 mm F1 = 100 kg		
CT41 50	500	5	5	5	5	5	5	5		
CT41 100	1000	12	12	12	12	12	12	12		
CT41 150	1500	17	17	17	17	17	17	17		
CT41 200	2000	22	22	22	22	22	22	22		

Çiftli C Profil Tavan Tespit (42x41) / Double C Channel Hanging Support (42x41)

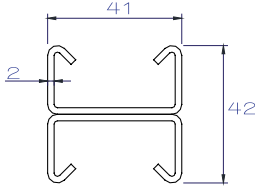

C PROFİL TAVAN TESPİT 42x41 / C CHANNEL HANGING SUPPORT 42x41

Ürün Kodu / Product Code		(L) Boy Length	(T) Kalınlık Thickness	(W) Ağırlık Weight
Pregalvaniz (PG)	Sıcak Daldırma (HDG)	(mm)	(mm)	(kg/adet)
EK CT42 25 PG	EK CT42 25 HDG	250	2,00	1,94
EK CT42 50 PG	EK CT42 50 HDG	500	2,00	2,75
EK CT42 75 PG	EK CT42 75 HDG	750	2,00	3,56
EK CT42 100 PG	EK CT42 100 HDG	1000	2,00	4,37
EK CT42 125 PG	EK CT42 125 HDG	1250	2,00	5,18
EK CT42 150 PG	EK CT42 150 HDG	1500	2,00	5,98

C Profil Tavan Tespit (83x41) / C Channel Hanging Support (83x41)

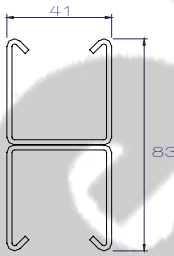

C PROFİL TAVAN TESPİT 83x41 / C CHANNEL HANGING SUPPORT 83x41

Ürün Kodu / Product Code		(L) Boy Length	(T) Kalınlık Thickness	(W) Ağırlık Weight
Pregalvaniz (PG)	Sıcak Daldırma (HDG)	(mm)	(mm)	(kg/adet)
EK CT83 25 PG	EK CT83 25 HDG	250	2,00	2,33
EK CT83 50 PG	EK CT83 50 HDG	500	2,00	3,28
EK CT83 75 PG	EK CT83 75 HDG	750	2,00	4,68
EK CT83 100 PG	EK CT83 100 HDG	1000	2,00	6,09
EK CT83 125 PG	EK CT83 125 HDG	1250	2,00	7,49
EK CT83 150 PG	EK CT83 150 HDG	1500	2,00	8,89

C Profil için Yaylı Somun - Kare Somun / Spring Nut - Square Nut for C Channel

YAYLI SOMUN / SPRING NUT

Ürün Kodu / Product Code	(S) Ebat Size (mm)	(W) Ağırlık Weight (kg/adet)
Galvaniz		
NYS 2M8	M8x20	0,05
NYS 3M8	M8x30	0,05
NYS 2M10	M10x20	0,05
NYS 3M10	M10x30	0,05
NYS 2M12	M12x20	0,04
NYS 2M12	M12x30	0,04

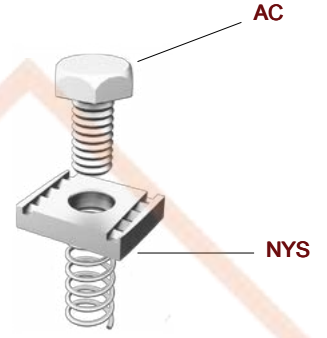

KARE SOMUN / SQUARE NUT

Ürün Kodu / Product Code	(D) Delik Çapı Hole Diameter (mm)	(W) Ağırlık Weight (kg/adet)
Galvaniz		
NS M8	M8	0,04
NS M10	M10	0,04
NS M12	M12	0,04

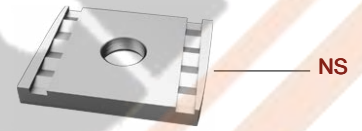

All nuts required a hexagonal head bolts and washers
Yukarıdaki somunları Altıgen başlı civata ve pul ile kullanınız.

C Profil için Civatalar / Bolts for C Channel

ALTİGEN BAŞLI CİVATA / HEXAGONAL BOLT

Ürün Kodu / Product Code	(S) Ebat Size (mm)	(W) Ağırlık Weight (kg/adet)
Galvaniz		
AC M8 25	M8x25	0,014
AC M8 40	M8x30	0,020
AC M10 25	M10x25	0,024
AC M10 30	M10x30	0,028
AC M10 40	M10x40	0,034
AC M10 60	M10x60	0,050
AC M12 25	M12x25	0,034
AC M12 30	M12x30	0,039
AC M20 40	M12x40	0,050
AC M12 60	M12x60	0,070

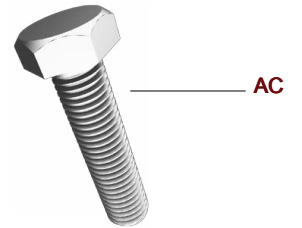

T CİVATA / T BOLT

Ürün Kodu / Product Code	(S) Ebat Size (mm)	(W) Ağırlık Weight (kg/adet)
Galvaniz		
NTS 2M8	M8	0,06
NTS 3M8	M8	0,07
NTS 2M10	M10	0,07
NTS 3M10	M10	0,08
NTS 2M12	M12	0,08
NTS 2M12	M12	0,09

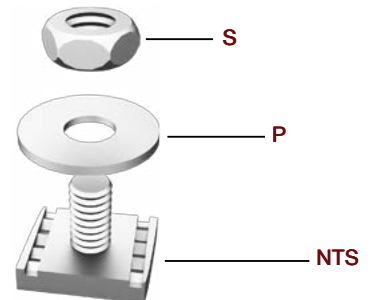

C Profil Aksesuarları / C Channel Accessories

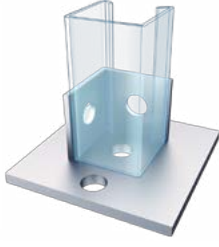

CDB-01

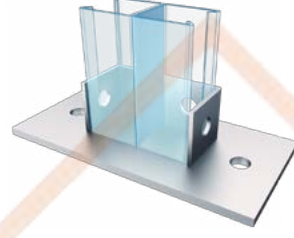

CDB-02

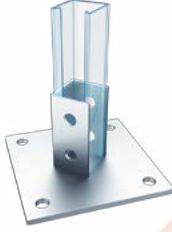

EK CDB-03

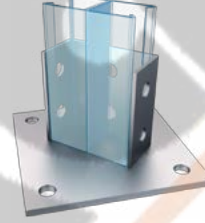

EK CDB-04



EK CDB-05



EK CDB-06

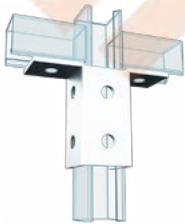

EK CDB-07

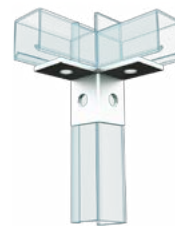

EK CDB-08

C Profil Aksesuarları / C Channel Accessories

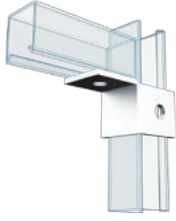

EK CDB-09

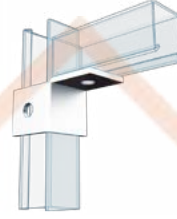

EK CDB-10

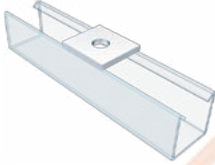

EK CYB-01

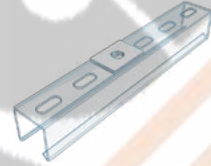

EK CYB-02

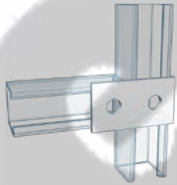

EK CYB-03

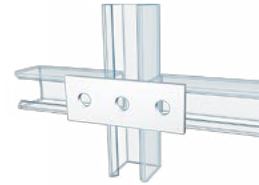

EK CYB-04



EK CYB-05

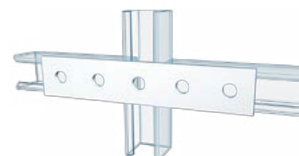

EK CYB-06

C Profil Aksesuarları / C Channel Accessories

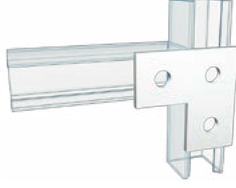

EK CYB-07

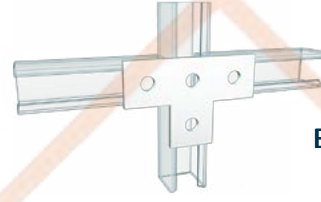

EK CYB-08

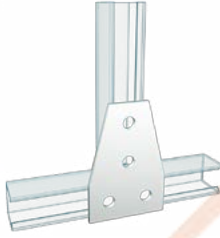

EK CYB-09

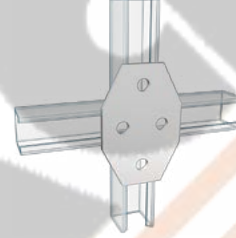

EK CYB-10



EK CB-11



EK CB-12



EK CB-13



EK CB-14

C Profil Aksesuarları / C Channel Accessories



EK CB-15



EK CB-16



EK CB-17

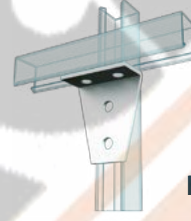

EK CB-18

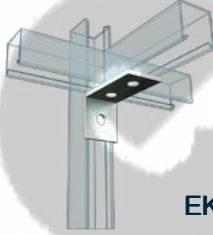

EK CB-19



EK CB-20

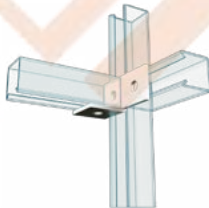

EK CB-21

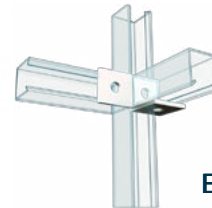

EK CB-22

C Profil Aksesuarları / C Channel Accessories

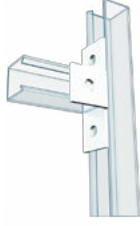

EK CB-23

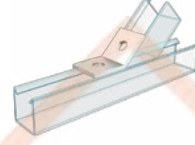

EK CB-24

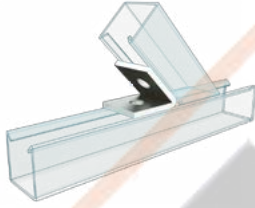

EK CB-25

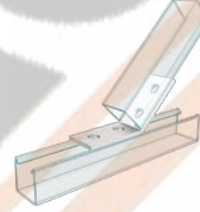

EK CB-26

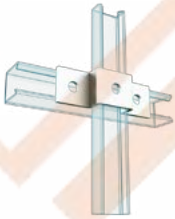

EK CB-30

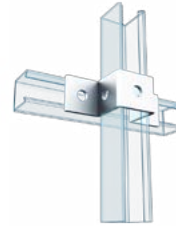

EK CB-31

C Profil Aksesuarları / C Channel Accessories

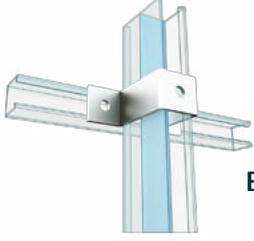

EK CB-32

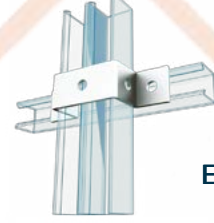

EK CB-33

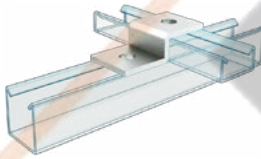

EK CB-34

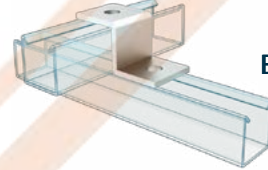

EK CB-35

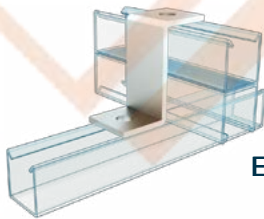

EK CB-36

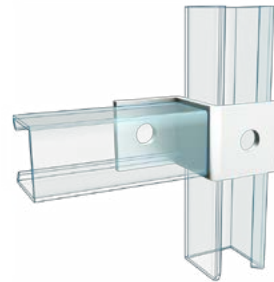

EK CB-37

C Profil Aksesuarları / C Channel Accessories

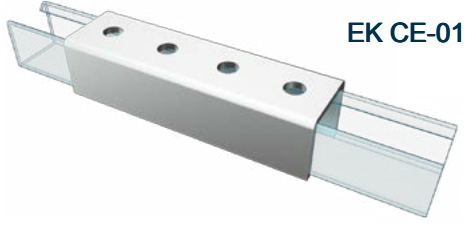

EK CE-01

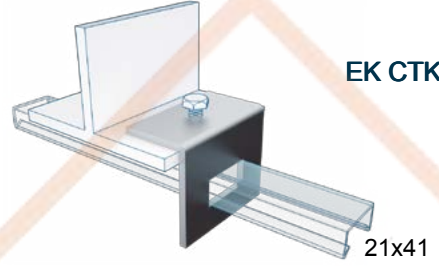

EK CTK-01

21x41

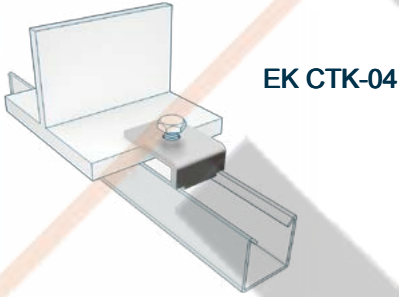

EK CTK-04

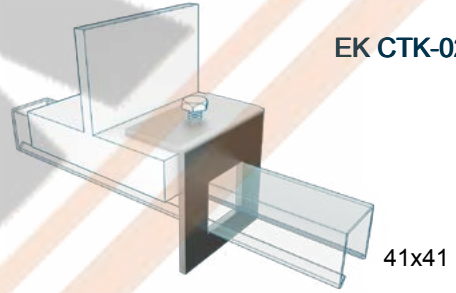

EK CTK-02

41x41

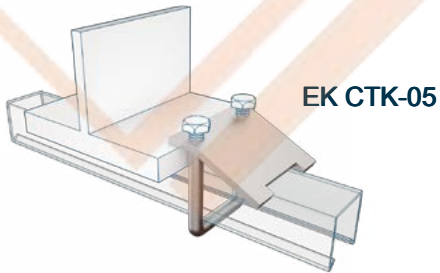

EK CTK-05

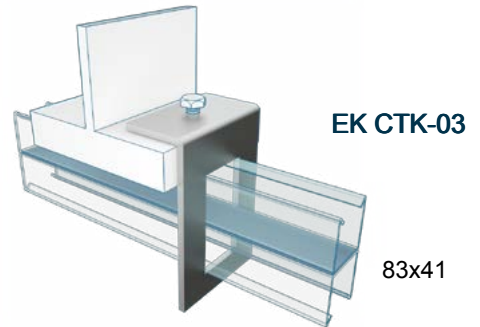

EK CTK-03

83x41

NPI Demir Destek (80x42) / NPI Steel Support (80x42)

NPI DEMİR DESTEK (80x42) / NPI STEEL SUPPORT (80x42)



Ürün Kodu / Product Code		(L) Boy Length	(W) Ağırlık Weight
Elektro galvaniz (EG)	Sıcak Daldırma (HDG)	(mm)	(kg/adet)
I 80 40 EG	I 80 40 HDG	400	2,38
I 80 50 EG	I 80 50 HDG	500	2,98
I 80 60 EG	I 80 60 HDG	600	3,57
I 80 70 EG	I 80 70 HDG	700	4,17
I 80 80 EG	I 80 80 HDG	800	4,78
I 80 90 EG	I 80 90 HDG	900	5,36
I 80 100 EG	I 80 100 HDG	1000	5,95
I 80 120 EG	I 80 120 HDG	1200	7,14
I 80 140 EG	I 80 140 HDG	1400	8,33
I 80 150 EG	I 80 150 HDG	1500	8,93
I 80 175 EG	I 80 175 HDG	1750	10,41
I 80 200 EG	I 80 200 HDG	2000	11,90
I 80 300 EG	I 80 300 HDG	3000	17,85
I 80 600 EG	I 80 600 HDG	6000	35,70

On request different lengths are produced.
Talep üzerine değişik boylarda imalat yapılır.

NPI Tavan Desteği / NPI Hanging Support

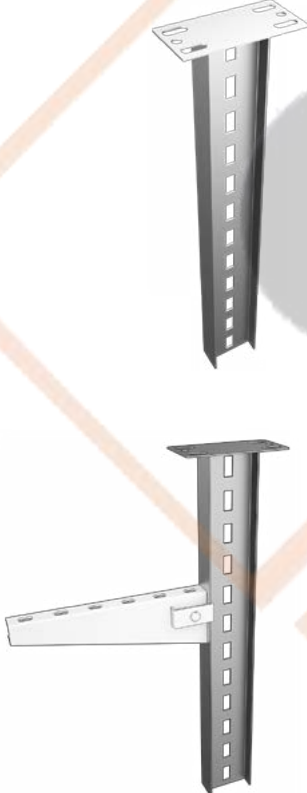

NPI TAVAN DESTEĞİ / NPI HANGING SUPPORT

Ürün Kodu / Product Code		(L) Boy Length	(W) Ağırlık Weight
Elektro galvaniz (EG)	Sıcak Daldırma (HDG)	(mm)	(kg/adet)
IT 80 40 EG	IT 80 40 HDG	400	3,00
IT 80 50 EG	IT 80 50 HDG	500	3,60
IT 80 60 EG	IT 80 60 HDG	600	4,20
IT 80 70 EG	IT 80 70 HDG	700	4,80
IT 80 80 EG	IT 80 80 HDG	800	5,39
IT 80 90 EG	IT 80 90 HDG	900	5,99
IT 80 100 EG	IT 80 100 HDG	1000	6,58
IT 80 120 EG	IT 80 120 HDG	1200	7,77
IT 80 140 EG	IT 80 140 HDG	1400	8,96
IT 80 150 EG	IT 80 150 HDG	1500	9,56
IT 80 175 EG	IT 80 175 HDG	1750	11,00
IT 80 200 EG	IT 80 200 HDG	2000	12,53

On request different lengths are produced.
Talep üzerine değişik boylarda imalat yapılır.

NPI Destek Konsolu / NPI Support Bracket



NPI DESTEK KONSOLU / NPI SUPPORT BRACKET

Ürün Kodu / Product Code		(L) Boy Length	(W) Ağırlık Weight
Elektro galvaniz (EG)	Sıcak Daldırma (HDG)	(mm)	(kg/adet)
IK 10 EG	IK 10 HDG	100	0,56
IK 16 EG	IK 16 HDG	160	0,72
IK 20 EG	IK 20 HDG	200	0,83
IK 26 EG	IK 26 HDG	260	0,99
IK 30 EG	IK 30 HDG	300	1,10
IK 40 EG	IK 40 HDG	400	1,36
IK 45 EG	IK 45 HDG	450	1,49
IK 50 EG	IK 50 HDG	500	1,63
IK 60 EG	IK 60 HDG	600	1,90
IK 70 EG	IK 70 HDG	700	2,16
IK 80 EG	IK 80 HDG	800	2,43
IK 90 EG	IK 90 HDG	900	2,70
IK 100 EG	IK 100 HDG	1000	2,96

On request different lengths are produced.
Talep üzerine değişik boylarda imalat yapılır.

NPI Tavan Tespit Elemanları / NPI Support Ceiling Fixing Parts

Stable
Sabit



EK ITS-01

Variable, Lengthwise
Hareketli, Boyuna



EK ITH-01

Variable, Crosswise
Hareketli, Çapraz



EK ITH-02

NPI Demir Destek Birleştirme Elemanı / NPI Support Connector

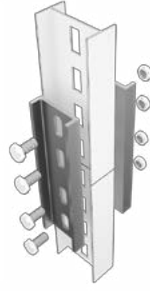

EK İBE

NPI Demir Taşıma Değerleri / NPI Support Static Values

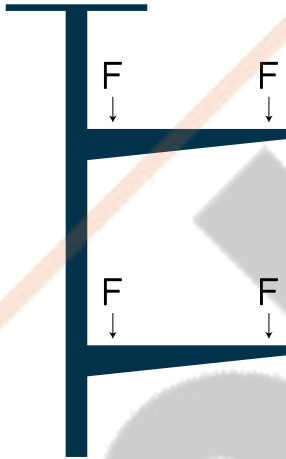

Maximum Total Load F, in kg

Bracket Length in mm

IT Support L,mm	100	200	300	400	500	600
500	850	650	550	450	400	350
1000	700	500	400	300	275	250
1500	550	400	300	250	200	175
2000	400	300	250	200	175	150

Calculated maximum bending of the end for ceiling support is between 3-8 mm

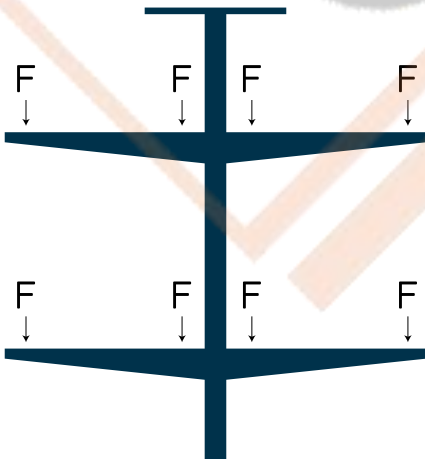

Maximum Total Load F, in kg

Bracket Length in mm

IT Support L,mm	100	300	400	500	600
500	1500	1200	1000	800	700
1000	1250	1000	800	650	575
1500	1000	800	650	525	450
2000	750	600	500	400	350

Maximum total load F= cable weight+ cable tray weight+bracket weight+ support weight

The concrete and anchor load values should also be considerable for above installation conditions

NPI Demir Destek Köşe Bağlantı Elemanı-1 / NPI Support Angle Connector-1

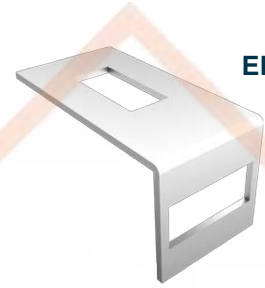
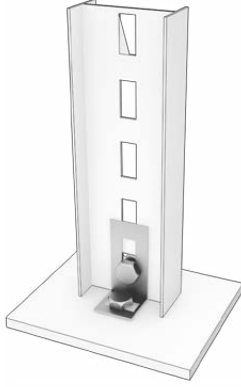

EK IDP 01

NPI Demir Destek Köşe Bağlantı Elemanı-2 / NPI Support Angle Connector-2

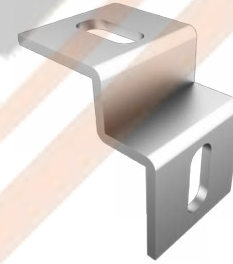

EK IDP 02

NPI Demir Destek Köşe Bağlantı Elemanı-3 / NPI Support Angle Connector-3

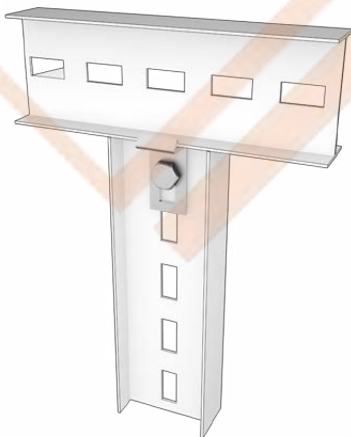

EK IDP 03

NPI Demir Destek Bağlantı Elemanı / NPI Support Connector

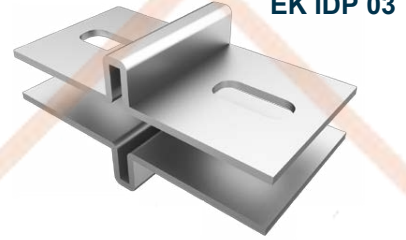
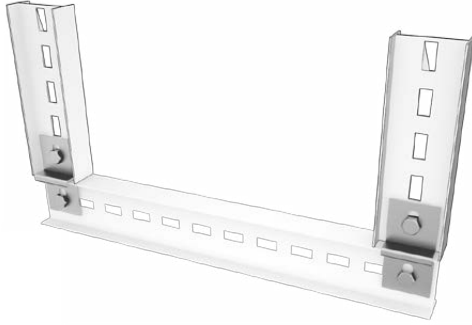

EK IDP 03

NPI Destek Tespit Kroşesi / NPI Support Clamp Part

NPI DESTEK TESPİT KROŞESİ / NPI SUPPORT CLAMP PART

Ürün Kodu / Product Code		(H) Yükseklik Height (mm)	(W) Ağırlık Weight (kg/adet)
Elektro galvaniz (EG)	Sıcak Daldırma (HDG)		
ITK 5 EG	ITK 5 HDG	5	0,115
ITK 10 EG	ITK 10 HDG	10	0,124
ITK 15 EG	ITK 15 HDG	15	0,132
ITK 20 EG	ITK 20 HDG	20	0,141
ITK 25 EG	ITK 25 HDG	25	0,150

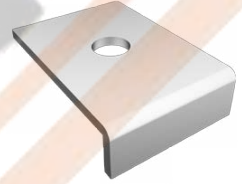

NPI Destek Tespit Kelepçesi / NPI Support Clamp

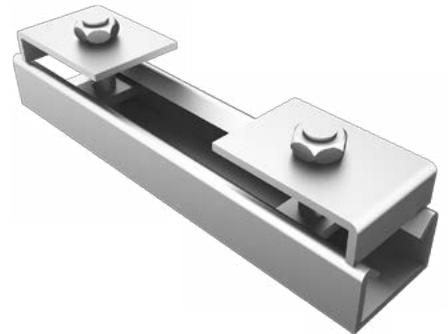
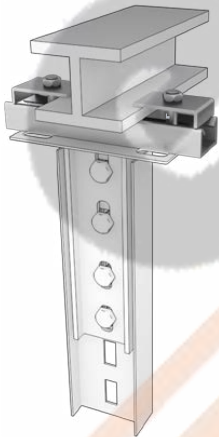

NPI DESTEK TESPİT KELEPÇESİ / NPI SUPPORT CLAMP

Ürün Kodu / Product Code		(H) Yükseklik Height (mm)	(W) Ağırlık Weight (kg/adet)
Elektro galvaniz (EG)	Sıcak Daldırma (HDG)		
ITKA 5 EG	ITKA 5 HDG	5	0,580
ITKA 10 EG	ITKA 10 HDG	10	0,595
ITKA 15 EG	ITKA 15 HDG	15	0,610
ITKA 20 EG	ITKA 20 HDG	20	0,625
ITKA 25 EG	ITKA 25 HDG	25	0,640

L Profil Destek (40x40) / L Profile Support (40x40)

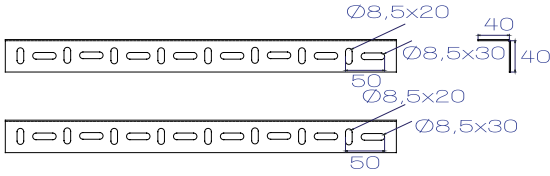

L PROFİL DESTEK (40x40) / L PROFILE SUPPORT (40x40) (CUT & USE)

Ürün Kodu / Product Code		(L) Boy Length	(T) Kalınlık Thickness	(W) Ürt. Ağırlık Mnf. Weight
Pregalvaniz (PG)	Sıcak Daldırma (HDG)	(mm)	(mm)	(kg/mt)
EK L40 PG	EK L40 HDG	2500	1,5	0,95

L Destek Tavan Tespit / L Support Ceiling Fixing Part

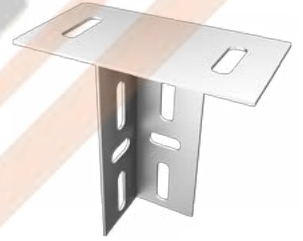
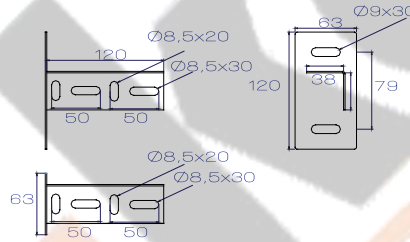
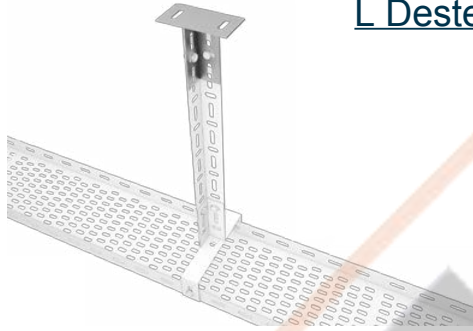

L PROFİL TAVAN DESTEĞİ / L SUPPORT HANGING SUPPORT

Ürün Kodu / Product Code		(L) Boy Length	(W) Ağırlık Weight
Pregalvaniz (PG)	Sıcak Daldırma (HDG)	(mm)	(kg/adet)
L40T 10 PG	L40T 10 HDG	120	0,38
L40T 30 PG	L40T 30 HDG	300	0,63
L40T 40 PG	L40T 40 HDG	400	0,77
L40T 50 PG	L40T 50 HDG	500	0,91
L40T 100 PG	L40T 100 HDG	1000	1,62

L Destek Kanal Taşıyıcı / L Support Tray Carrier

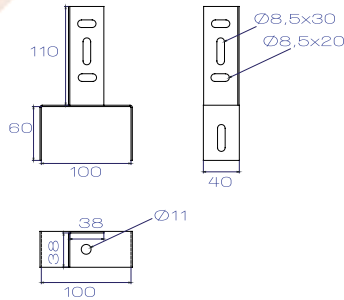
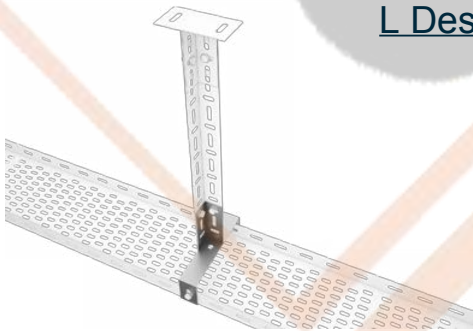

L DESTEK KANAL TAŞIYICI / L SUPPORT TRAY CARRIER

Ürün Kodu / Product Code		(W) En Width	(W) Ağırlık Weight
Pregalvaniz (PG)	Sıcak Daldırma (HDG)	(mm)	(kg/adet)
L40K 05 PG	L40K 05 HDG	50	0,38
L40K 10 PG	L40K 10 HDG	100	0,45
L40K 16 PG	L40K 16 HDG	160	0,54
L40K 20 PG	L40K 20 HDG	200	0,60

Kanal Civatası ve Somunu / Bolt & Nut for Cable Tray

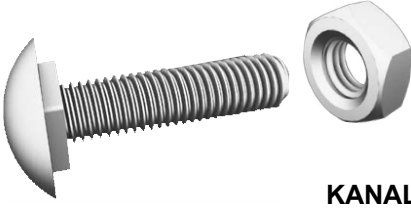

KANAL CİVATASI VE SOMUNU / BOLT & NUT FOR CABLE TRAY

Ürün Kodu / Product Code		Ebat Size	Ağırlık Weight
Galvaniz	Dakromet	(mm)	(kg/adet)
CS M8	CS M8 D	M8X15	0,012

Altıgen Somun / Hexagonal Nut



SOMUN / NUT

Ürün Kodu / Product Code		(S) Ebat Size	Ağırlık Weight
Galvaniz	Dakromet	(mm)	(kg/adet)
S M8	S M8 D	M8	0,01
S M10	S M10 D	M10	0,01
S M12	S M12 D	M12	0,02

Flanşlı Somun / Flanged Nut



FLANŞLI SOMUN / FLANGED NUT

Ürün Kodu / Product Code		(S) Ebat Size	Ağırlık Weight
Galvaniz	Dakromet	(mm)	(kg/adet)
S M8	S M8 D	M8	0,01
S M10	S M10 D	M10	0,01
S M12	S M12 D	M12	0,02

Pul / Flat Washer



PUL / FLAT WASHER

Ürün Kodu / Product Code		(S) Ebat Size	Ağırlık Weight
Galvaniz	Dakromet	(mm)	(kg/adet)
P M8	P M8 D	M8	0,01
P M10	P M10 D	M10	0,01
P M12	P M12 D	M12	0,01

Yaylı Rondela / Spring Lock Washer



YAYLI RONDELA / SPRING LOCK WASHER

Ürün Kodu / Product Code		(S) Ebat Size (mm)	Ağırlık Weight (kg/adet)
Galvaniz	Dakromet		
YP M8	YP M8 D	M8	0,01
YP M10	YP M10 D	M10	0,01
YP M12	YP M12 D	M12	0,01

Tırtıllı Rondela / Serrated Lock Washer

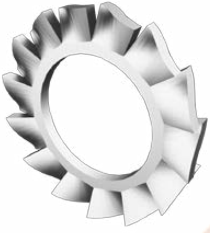

TIRTILLI RONDELA / SERRATED LOCK WASHER

Ürün Kodu / Product Code		(S) Ebat Size (mm)	Ağırlık Weight (kg/adet)
Galvaniz	Dakromet		
TP M8	TP M8 D	M8	0,01
TP M10	TP M10 D	M10	0,01
TP M12	TP M12 D	M12	0,01

Altıgen Başlı Civata / Hexagonal Head Bolt

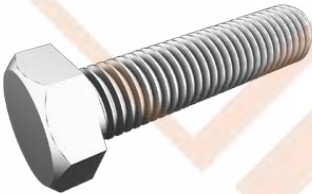

ALTIGEN BAŞLI CİVATA / HEXAGONAL BOLT

Ürün Kodu / Product Code	(S) Ebat Size (mm)	(W) Ağırlık Weight (kg/adet)
Galvaniz		
AC M8 25	M8x25	0,014
AC M8 40	M8x30	0,020
AC M10 25	M10x25	0,024
AC M10 30	M10x30	0,028
AC M10 40	M10x40	0,034
AC M10 60	M10x60	0,050
AC M12 25	M12x25	0,034
AC M12 30	M12x30	0,039
AC M20 40	M12x40	0,050
AC M12 60	M12x60	0,070

Kopilya / Splint Pin



KOPİLYA / SPLIT PIN

Ürün Kodu / Product Code	(S) Ebat Size	Ağırlık Weight
Galvaniz	(mm)	(kg/adet)
GD M8	M6	0,07

Çakmalı Tip Çelik Dübel / Drop-in Anchor



ÇAKMALI TİP ÇELİK DÜBEL / DROP-IN ANCHOR

Ürün Kodu / Product Code	(S) Ebat Size	Ağırlık Weight
Galvaniz	(mm)	(kg/adet)
CD M8	M8	0,01
CD M10	M10	0,02
CD M12	M12	0,05

Çekmeli Tip Çelik Dübel / Draw-in Anchor



ÇEKME Lİ TİP ÇELİK DÜBEL / DRAW-IN ANCHOR

Ürün Kodu / Product Code	(S) Ebat Size	Ağırlık Weight
Galvaniz	(mm)	(kg/adet)
SD M8	M8	0,02
SD M10	M10	0,03
SD M12	M12	0,05

Saç Gömleklİ Tip Çelik Dübel / Sleeve Anchor



SAÇ GÖMLEKLİ TİP ÇELİK DÜBEL / SLEEVE ANCHOR

Ürün Kodu / Product Code	(S) Ebat Size	Ağırlık Weight
Galvaniz	(mm)	(kg/adet)
GD M8	M8	0,02
GD M10	M10	0,03
GD M12	M12	0,05

Silme Demir / Steel Flat Bars

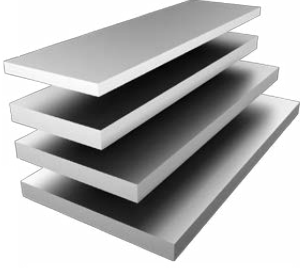

SİLME DEMİR / STEEL FLAT BARS

Ürün Kodu / Product Code	(W) En Width (mm)	(T) Kalınlık Thickness (mm)	(W) Ağırlık Weight (kg/mt)
Sıcak Daldırma (HDG)			
SD 30X3 HDG	30	3	0,71
SD 30X5 HDG	30	5	1,18
SD 40X5 HDG	40	5	1,57
SD 50X5 HDG	50	5	1,97

Standard length 6000mm; on request any lengths between 100-5900mm

Köşebent Demir / Steel Angle Bars

LD 50X50X5

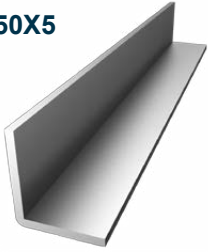

LD 50X50X5D



KÖŞEBENT DEMİR / STEEL ANGLE BARS

Ürün Kodu / Product Code	(S) Ebat Size (mm)	(T) Kalınlık Thickness (mm)	(W) Ürt. Ağırlık Mnf. Weight (kg/mt)
Sıcak Daldırma (HDG)			
LD 25X25X3 HDG	30	3	1,12
LD 30X30X3 HDG	30	3	1,40
LD 30X30X4 HDG	40	4	1,78
LD 40X40X4 HDG	50	4	2,42
LD 50X50X5 HDG	30	5	3,77
LD 40X40X4D HDG	30	4	2,42
LD 50X50X5D HDG	40	5	3,77

Standard length 6000mm; on request any lengths between 100-5900mm

NPU Demir / NPU Steel

NPU 80X45

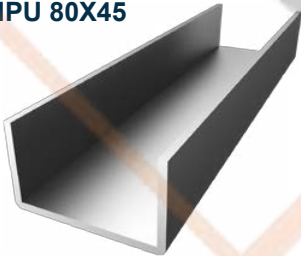

NPU 80X45D



NPU DEMİR / NPU STEEL

Ürün Kodu / Product Code	(S) Ebat Size (mm)	(T) Kalınlık Thickness (mm)	(W) Ürt. Ağırlık Mnf. Weight (kg/mt)
Sıcak Daldırma (HDG)			
NPU 65X42 HDG	65X42	5,5	7,09
NPU 80X45 HDG	80X45	6,0	8,64
NPU 65X42D HDG	65X42	5,5	7,09
NPU 80X45D HDG	80X45	6,0	8,64

Standard length 6000mm; on request any lengths between 100-5900mm

NPI Demir / NPI Steel

NPI 80X42

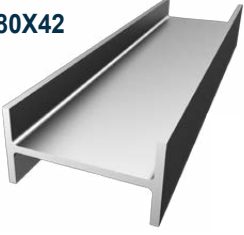

NPI 80X42D



NPI DEMİR / NPI STEEL

Ürün Kodu / Product Code	(S) Ebat	(T) Kalınlık	(W) Urt. Ağırlık
	Size	Thickness	Mnf. Weight
Sıcak Daldırma (HDG)	(mm)	(mm)	(kg/mt)
NPI 80X42 HDG	80x42	3,9	5,95
NPI 100X50 HDG	100x50	4,5	8,32
NPI 80X42D HDG	80x42	3,9	5,95
NPI 100X50D HDG	100x50	4,5	8,32

Standard length 6000mm; on request any lengths between 100-5900mm

T Demir / T Steel Bars

TD 40X40X4

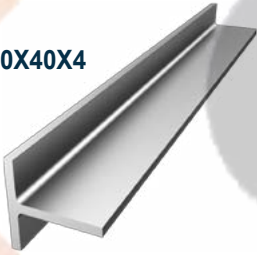

TD 40X40X4D



T DEMİR / T STEEL BARS

Ürün Kodu / Product Code	(S) Ebat	(T) Kalınlık	(W) Urt. Ağırlık
	Size	Thickness	Mnf. Weight
Sıcak Daldırma (HDG)	(mm)	(mm)	(kg/mt)
TD 40X40X4 HDG	40x40	4,0	2,38
TD 40X40X4D HDG	40x40	4,0	2,38

Standard length 6000mm; on request any lengths between 100-5900mm